

SHARP®

MODEL: MX-M850
MX-M950
MX-M1100

DIGITAL MULTIFUNCTIONAL SYSTEM

Quick Start Guide



Keep this manual close at hand for reference whenever needed.

General information

Functions of the machine and procedures for placing originals and loading paper.

Copying

Using the copy function.

Printing

Using the printer function.

Image sending

Using the Image Send function.

Document filing

Storing jobs as files on the hard drive.

Manual finishing

Finishing functions using the inserter.

System settings

Configuring settings to make the machine easier to use.

MANUALS PROVIDED WITH THE MACHINE

Printed manuals and manuals in PDF format are provided with the machine. The manuals in PDF format are stored on the hard drive in the machine.

The printed manuals contain information that you should know before using the machine, including the basic procedures for operating the machine. Please read these manuals well.

The manuals in PDF format provide detailed explanations of the functions of the machine. When the machine is used in a network environment, the PDF manuals can be viewed at any time by simply downloading them using a Web browser.

Printed manuals

Quick Start Guide (this manual)

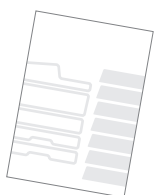

This manual is intended to help you get started using the many basic and convenient functions of the machine.

When you are ready to learn about the machine in more detail, see the manuals in PDF format described on the next page.

Maintenance Guide



This manual explains maintenance procedures such as how to replace supplies and remove paper misfeeds.

Safety Guide



This manual contains instructions for using the machine safely and lists the specifications of the machine and its peripheral devices.

Software Setup Guide



This manual explains how to install and configure the software that is required to use the printer function and other functions of the machine that are used from a computer.

Manuals in PDF format

Manuals in PDF format can be downloaded from the Web server* in the machine.

The manuals contain detailed explanations of the procedures for using the machine. To download the PDF manuals, see "How to download the manuals in PDF format" (page 3).



User's Guide

This manual explains the basic procedures for using the machine, such as how to load paper.



Copier Guide

This manual provides detailed explanations of the procedures for using the copy function.



Printer Guide

This manual provides detailed explanations of the procedures for using the print function.



Image Send Guide

This manual provides detailed explanations of the procedures for using the image send function (scan, USB memory scan, Internet fax, fax, and data entry).



Document Filing Guide

This manual provides detailed explanations of the procedures for using the document filing function. The document filing function allows you to save the document data of a copy or fax job, or the data of a print job, as a file on the machine's hard drive. The file can be called up as needed.



Administrator's Guide

This manual explains the settings and functions that are used to manage and control the machine, such as the system settings that require administrator rights.

* You will need the IP address of the machine in order to access the Web server in the machine. The IP address is configured in the Network Settings menu in the system settings.

ACCESSING THE WEB SERVER IN THE MACHINE

When the machine is connected to a network, the machine's built-in Web server can be accessed from a Web browser on your computer.

Opening the Web pages

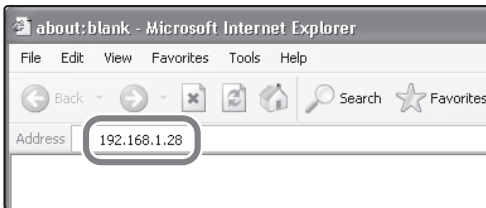

Access the Web server in the machine to open the Web pages.

Start a Web browser on a computer that is connected to the same network as the machine and enter the IP address of the machine.

Recommended Web browsers

Internet Explorer: 6.0 or higher (Windows®)

Netscape Navigator: 7.0 or higher

Safari: 1.2 or higher (Macintosh)

The Web page will appear.

The machine settings may require that user authentication be performed in order to open the Web page. Please ask the administrator of the machine for the password that is required for user authentication.

Checking the IP address

To check the IP address of the machine, print out the all custom setting list in the system settings.

SYSTEM
SETTINGS



1 Press the [SYSTEM SETTINGS] key.

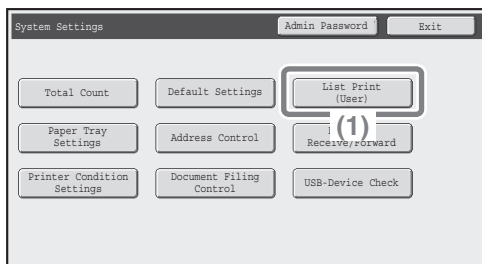

2 Select the all custom setting list in the touch panel.

(1) Touch the [List Print (User)] key.

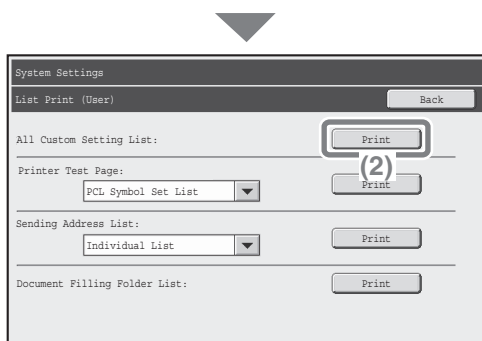

(2) Touch the [Print] key to the right of "All Custom Setting List".

The IP address is shown in the list that is printed.

How to download the manuals in PDF format

Manuals containing detailed information on the machine can be downloaded from the Web pages.

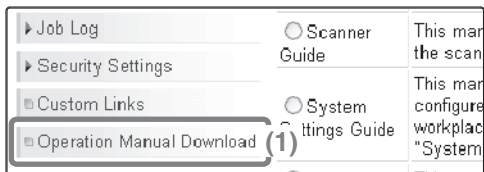

Download a manual in PDF format.

(1) Click [Operation Manual Download] in the menu of the Web page.



(2) Select the desired language.

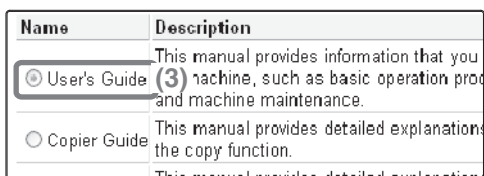

(3) Select the manual that you wish to download.

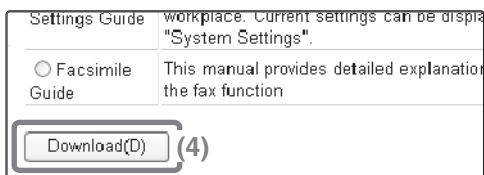

(4) Click the [Download] button.
The selected manual is downloaded.

TABLE OF CONTENTS

General information

PART NAMES AND FUNCTIONS	8
OPERATION PANEL	10
USING THE TOUCH PANEL	12
HOW TO LOG IN TO THE MACHINE (USER AUTHENTICATION)	13
HOME SCREEN	14
PLACING ORIGINALS	15
CHANGING PAPER IN A TRAY	16
FINISHING	25

Copying

BASE SCREEN OF COPY MODE	28
MAKING COPIES	29
2-SIDED COPYING (Automatic Document Feeder)	30
COPYING ON SPECIAL PAPER (Bypass Copy)	31
SELECTING THE EXPOSURE AND IMAGE TYPE	33
FITTING THE COPY IMAGE TO THE PAPER (Automatic Ratio Selection)	34
ENLARGEMENT/REDUCTION (Preset Ratios / Zoom)	36
CHECKING COPIES BEFORE PRINTING (Proof Copy)	38
FINISHING	40
INTERRUPTING A COPY RUN (Interrupt Copy)	41
STORING COPY OPERATIONS (Job Programs)	42
SPECIAL MODES	44
SELECTING A SPECIAL MODE	45
CONVENIENT COPY FUNCTIONS	46

Printing

PRINTING	54
CANCELLING PRINTING (AT THE MACHINE)	61
SELECTING PRINT SETTINGS	62
CONVENIENT PRINTER FUNCTIONS	64

Image sending

IMAGE SEND FUNCTION	68
BASE SCREEN OF IMAGE SEND MODE	69
SCANNING AN ORIGINAL	70
SENDING A FAX	71
CONVENIENT TRANSMISSION METHODS	72
STORING A DESTINATION	74
SENDING THE SAME IMAGE TO MULTIPLE DESTINATIONS (Broadcast Transmission)	76
CHANGING THE EXPOSURE AND ORIGINAL IMAGE TYPE	77
CHANGING THE RESOLUTION	78
CHANGING THE FILE FORMAT	80
SPECIAL IMAGE SEND MODES	81
SELECTING A SPECIAL MODE	82
CONVENIENT IMAGE SEND FUNCTIONS	83

Document filing

DOCUMENT FILING	86
QUICKLY SAVING A JOB (Quick File)	88
APPENDING INFORMATION WHEN STORING A FILE (File)	89
SAVING A DOCUMENT ONLY (Scan to HDD)	91
PRINTING A SAVED FILE	92

Manual finishing

MANUAL FINISHING	94
USING MANUAL FINISHING	95

System settings

SYSTEM SETTINGS	98
SYSTEM SETTINGS MENU	100

General information

This section provides general information about the machine, including the names and functions of the parts of the machine and its peripheral devices, and the procedures for placing originals and loading paper.

▶ PART NAMES AND FUNCTIONS	8
▶ OPERATION PANEL	10
▶ USING THE TOUCH PANEL	12
▶ HOW TO LOG IN TO THE MACHINE (USER AUTHENTICATION)	13
▶ HOME SCREEN	14
▶ PLACING ORIGINALS	15
▶ CHANGING PAPER IN A TRAY	16
▶ FINISHING	25

PART NAMES AND FUNCTIONS

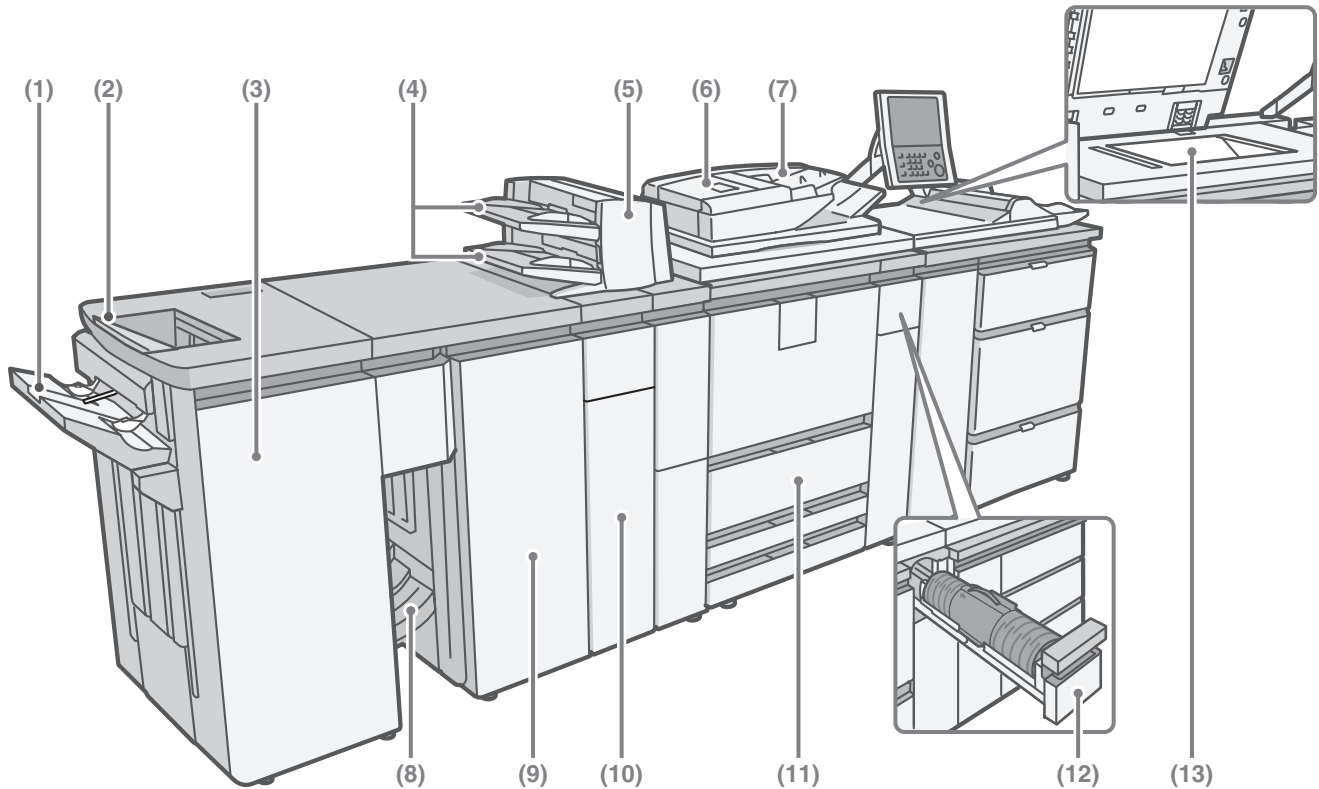

(1) Offset tray

Offset and stapled output are delivered to this tray.

(2) Top tray

Printed output is delivered to this tray.

(3) Finisher*

This can be used to staple output. When an optional punch unit is installed, holes can be punched in output.

(4) Paper trays

When using the inserter, load paper in this tray.

(5) Inserter*

This inserts covers and inserts into copy and print output. Paper loaded in the inserter can be stapled, punched, or folded.

(6) Automatic document feeder

This automatically feeds and scans multiple originals. Both sides of 2-sided originals can be scanned at once.

(7) Document feeder tray

Place the originals in this tray when using the automatic document feeder.

(8) Saddle stitch tray

Output folded at the centreline and stapled output are delivered to this tray.

(9) Saddle unit*

This is equipped with the pamphlet staple function, which staples output at the centreline.

(10) Folding unit*

Use this to fold the loaded paper in half.

(11) Machine trays

These hold paper. The machine has four trays.

(12) Toner cartridge installation cover

Open this cover to replace a toner cartridge.

(13) Document glass

Use this to scan a book or other original that cannot be fed through the automatic document feeder.

* Peripheral device. For more information, see "4. PERIPHERAL DEVICES" in the User's Guide.

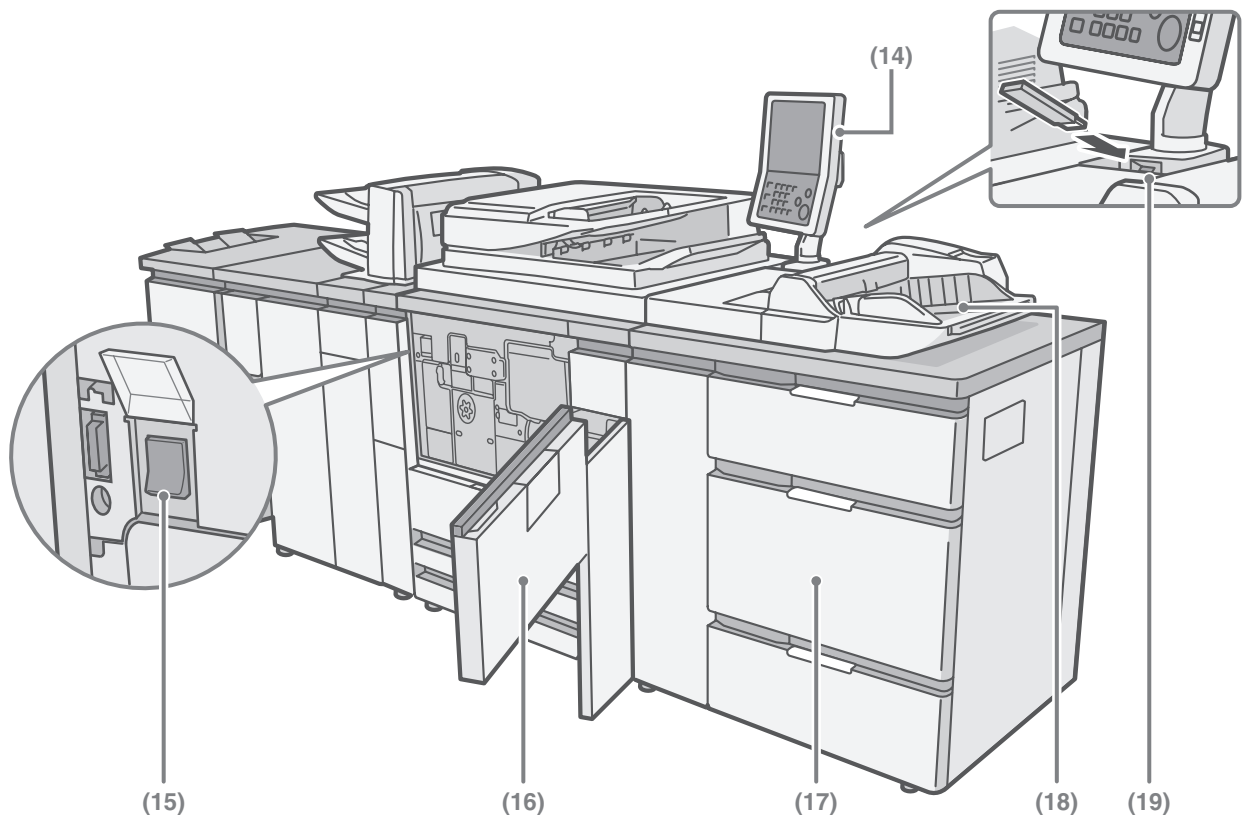

(14) Operation panel

(15) Main power switch

This is used to power on the machine.
When using the fax or Internet fax functions, keep this switch in the "on" position.

(16) Front cover

Open to power on the machine.

(17) Large capacity trays (MX-LCX5)*

These hold paper. Up to 4000 sheets can be loaded. Other optional paper trays include the large capacity trays (MX-LCX4), the large capacity tray (MX-LCX3N), and the large capacity tray (MX-LCX6).

(18) Bypass tray (MX-MFX2)*

Special types of paper can be fed from the bypass tray.
The optional bypass tray (MX-MFX1) is also available.

(19) USB connector (type A)

This is used to connect a USB memory or other USB device to the machine. For the USB cable, use a shielded type cable.

* Peripheral device. For more information, see "4. PERIPHERAL DEVICES" in the User's Guide.

OPERATION PANEL

Touch panel

Messages and keys appear in the LCD display. Operations are performed by directly touching the displayed keys with your fingers. When a key is touched, a beep sounds and the selected item is highlighted. This lets you check an operation as you perform it.

Status indicators

Green and red indicators light and blink to indicate the status of the machine. The green indicator is on the left side and the red indicator is on the right side. When the green indicator lights or blinks, the machine is operating normally. The red indicator will light up when toner is low or it is time for maintenance. When the machine stops operating due to a paper misfeed or out of toner, the red indicator will blink.

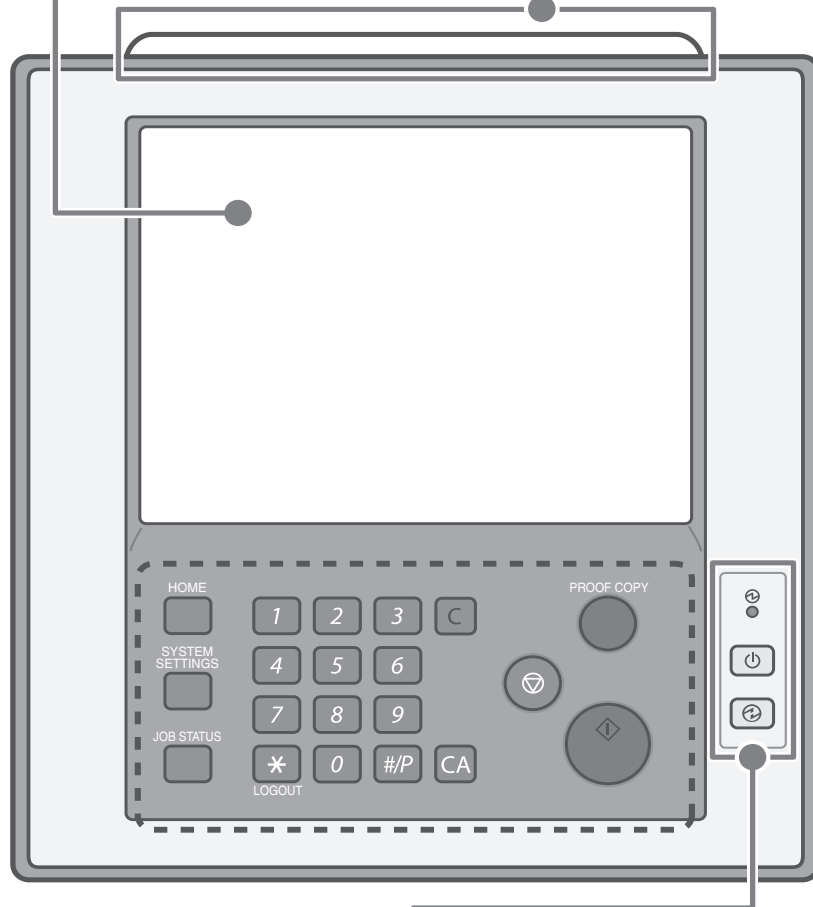

Main power indicator

This indicator lights when the main power is switched on. When auto power shutoff is in effect and data can be transmitted and received, the indicator lights orange.

[POWER] key (⏻)

Use this key to turn the machine power on and off.

[POWER SAVE] key (⏻)

Use this key to activate power save mode. The [POWER SAVE] key blinks when the machine is in power save mode. This key is also used to deactivate power save mode.

The keys inside  are explained on the next page.

[HOME] key

Touch this key to display the home screen. Keys of frequently used functions can be registered in this screen for quick access, making the machine easier to use.

[SYSTEM SETTINGS] key

Press this key to display the system settings screen. The system settings can be adjusted to make the machine easier to use, such as configuring paper tray settings and storing addresses.

[JOB STATUS] key

Press this key to view the job status screen. You can check the status of jobs and cancel jobs in the job status screen.

[CLEAR] key

Press this key to return settings such as the number of copies to "0".

[PROOF COPY] key

Use this to make a proof copy.

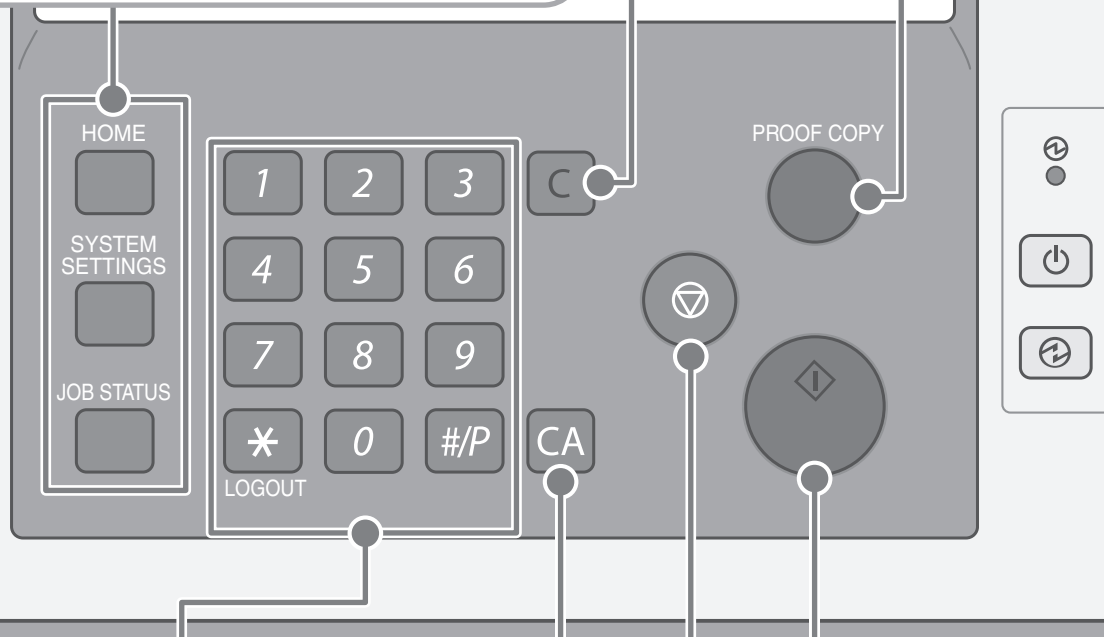
**Numeric keys**

These are used to enter the number of copies, fax numbers, and other numbers.

[LOGOUT] key ([*])

When user authentication is enabled, press this key to log out after using the machine. When using the fax function, this key can be pressed to send tone signals on a pulse dial line.

[#/P] key ([#/P])

Press this key to use a job program when using the copier function. When using the fax function, press this key to dial using a program.

[CLEAR ALL] key

Press this key to redo an operation from the beginning.

All settings will be cleared and operation will return to the initial state.

[START] key

Use this key to copy or scan an original. This key is also used to send a fax in fax mode.

[STOP] key

Press this key to stop a copy job or scanning of an original.

For details on the operation panel, see "OPERATION PANEL" in the User's Guide.

USING THE TOUCH PANEL

The touch keys that appear in the touch panel are grouped for easy operation. The layout and functions of the touch keys are explained below.

Mode select keys

[COPY] key

To use the copy function, touch this key to switch to copy mode. Keep your finger on the [COPY] key to view the machine's total page use count and amount of toner remaining.

[IMAGE SEND] key

To use the scan or fax function, touch this key to switch to image send mode.

[DOCUMENT FILING] key

When you wish to print or send a file stored on the hard drive, touch this key to switch to document filing mode.

[MANUAL FINISHING] key

When an inserter is installed and you wish to staple, punch, or fold paper without printing on it, touch this key to switch to manual finishing mode.

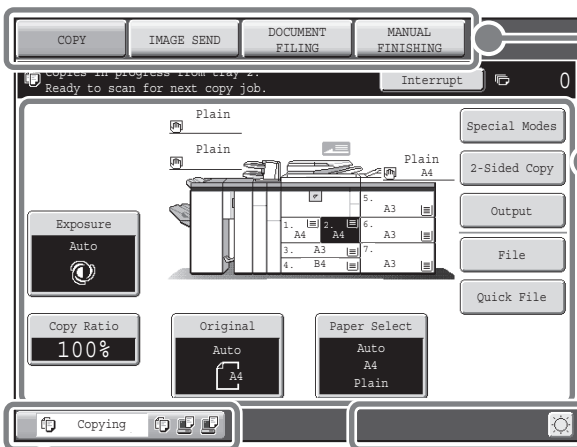

When the mode of the machine is changed, the base screen of the newly selected mode appears. Functions can be selected and settings checked in the base screen.

System display

This shows the touch panel brightness adjustment key, the status of transmission/reception, and the USB device connection status.

Job status display

This shows the mode icon and status of reserved jobs and the job in progress. This can be touched to show the job status screen.

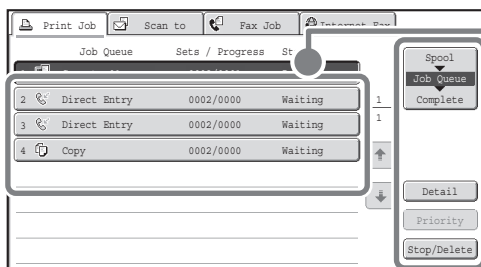

Jobs are displayed as a list of touch keys. The job keys appear in the order that they will be run. A job key can be touched to select it.

A selected job can be given priority and run ahead of other jobs, or a job waiting in the queue can be cancelled.

Using general keys

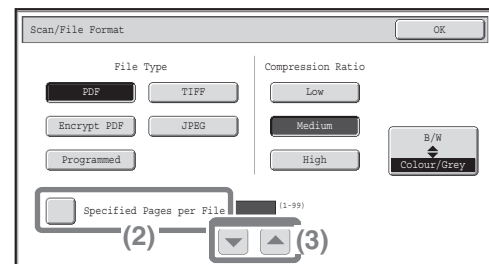
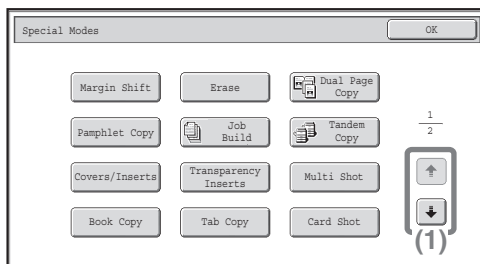

- (1) When the displayed screen is one of two or more screens, use the keys to switch through the screens.
- (2) When a checkbox is touched, a checkmark will appear to indicate that the setting is enabled.
- (3) The keys can be used to increase or decrease a value. To make a value change quickly, keep your finger on the key.

HOW TO LOG IN TO THE MACHINE (USER AUTHENTICATION)

User authentication is used to restrict the use of the machine to users who have been registered in the machine. When user authentication has been enabled by the administrator of the machine, users must log in before using the machine. There are several types of user authentication, and each has a different login method. When you have finished using the machine, log out.

User authentication methods

There are two methods for performing user authentication: login by user number and login by login name and password. Ask the administrator of the machine for the information that is required to log in. For more information on user authentication, see "USER AUTHENTICATION" in the User's Guide. The procedures for logging in by user number and by login name / password are explained in this section.

Login by user number

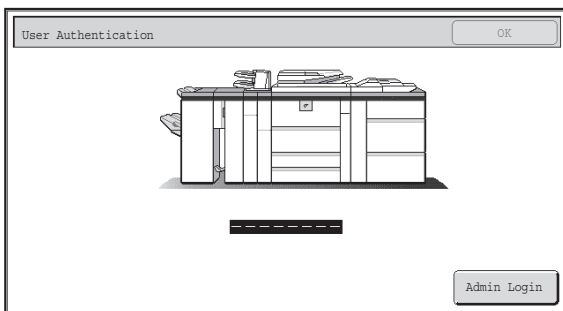

This method requires that you log in by entering your user number (5 to 8 digits).

Login by login name and password

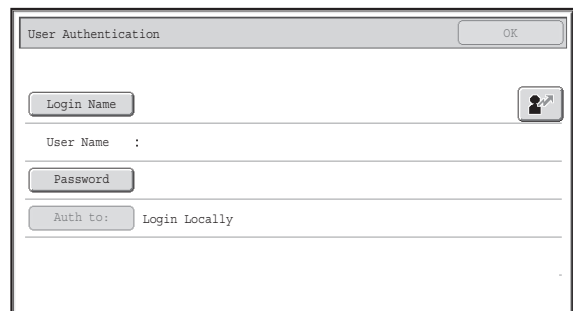

This login method requires that you enter your login name and password.

Logging out

When you have finished using the machine, log out. Logging out prevents unauthorised use of the machine.

How to log out

You can log out from any mode of the machine by pressing the [LOGOUT] key (⌘).

If a preset duration of time elapses after the machine is last used, the auto clear function will activate. When auto clear activates, logout automatically takes place.

HOME SCREEN

When the [HOME] key is pressed on the operation panel, the home screen appears in the touch panel. Shortcuts to functions can be registered as keys in the home screen. When a shortcut key is touched, the screen for that function appears. Register frequently used functions in the home screen to quickly and conveniently access those functions. When user authentication is used, the home screen of "Favourite Operation Group" can be displayed.

Register keys that you wish to show in the home screen in the system settings.

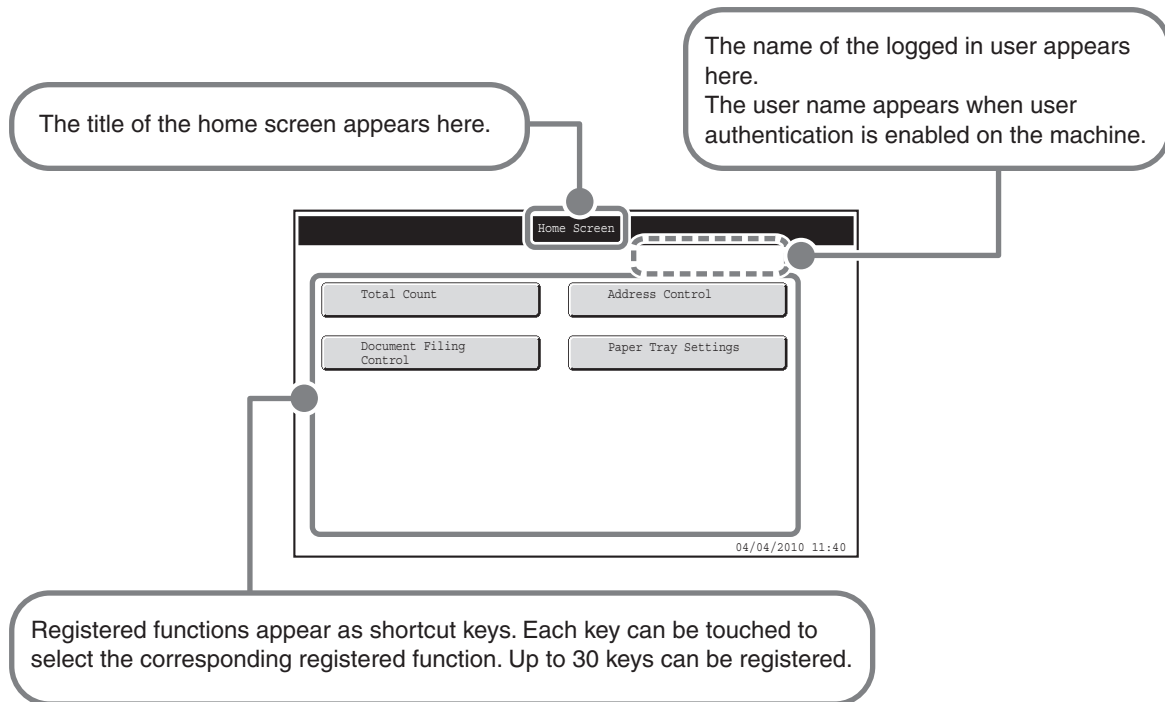

For detailed information on home screen settings, see "Favourite Operation Group Registration" and "Home Screen Settings" in the Administrator's Guide.

PLACING ORIGINALS

The automatic document feeder can be used to automatically scan many originals at once. This saves you the trouble of manually feeding each original.

For originals that cannot be scanned using the automatic document feeder, such as a book or a document with notes attached, use the document glass.

Using the automatic document feeder

When using the automatic document feeder, place the originals in the document feeder tray.

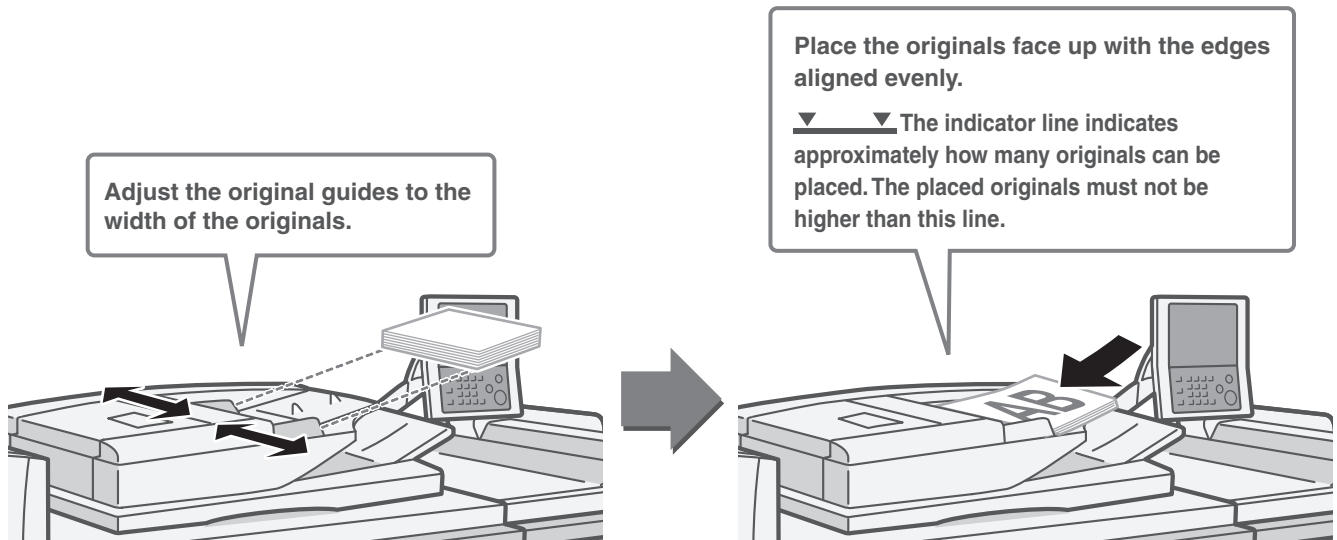

Using the document glass

Place the original face down.

Align the top left corner of the original with the tip of the ▼ mark in the far left corner of the glass.

Place the original face down.

To place a thick original such as a book with many pages, push up the far edge of the automatic document feeder and then close the automatic document feeder slowly. Take care that your fingers are not pinched when closing the automatic document feeder.

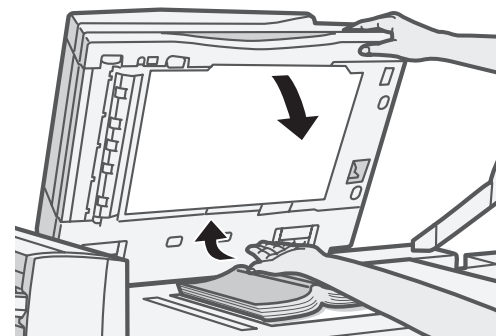

CHANGING PAPER IN A TRAY

Names of the trays

The names of the trays are shown below.

For the number of sheets of paper that can be loaded in each tray, see the following manuals:

- User's Guide, "PAPER TRAY SETTINGS"
- Safety Guide, "SPECIFICATIONS"

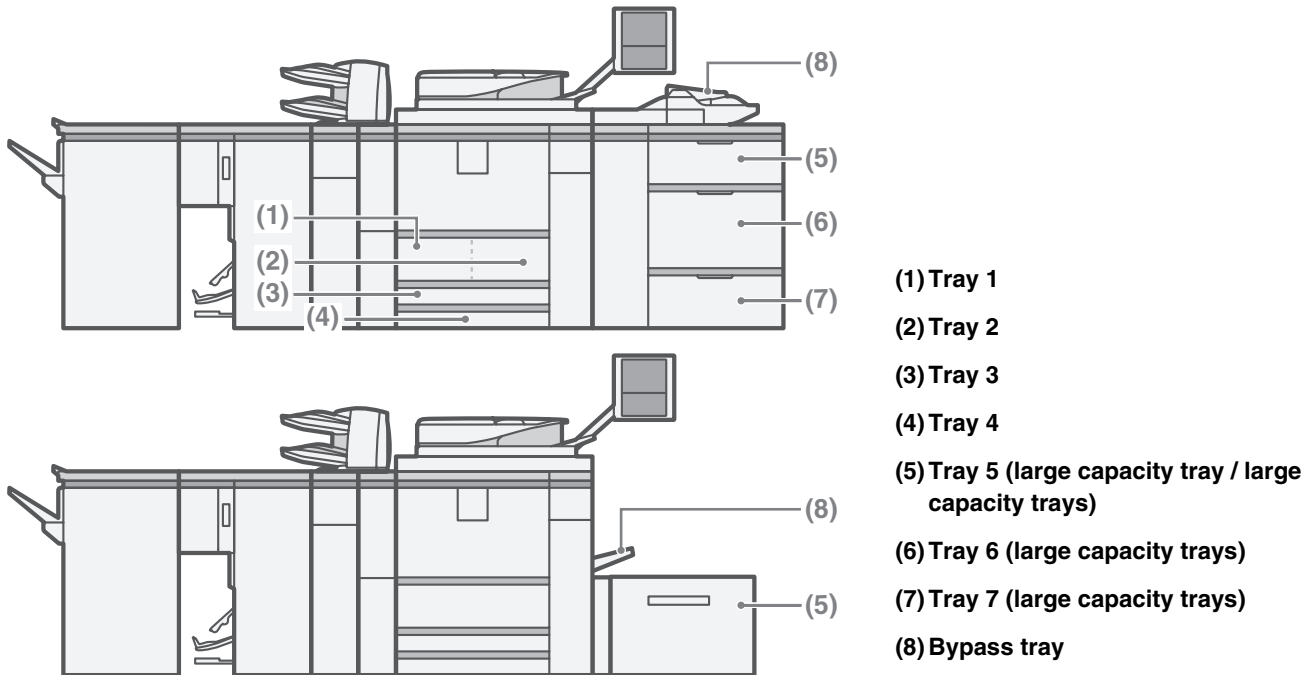

Print side face up or face down

When loading paper in a tray, the print side is loaded face up or face down depending on the tray.

Trays 1 to 4

Load the paper with the print side face down.

Bypass tray and trays 5 to 7

Load the paper with the print side face up.

Loading paper in a tray

To change the paper in a tray, load the desired paper in the tray and then change the tray settings in the machine to specify the loaded paper. The procedure for changing the tray paper size is explained below. As an example, the paper in tray 4 is changed from B4 (8-1/2" x 14") size plain paper to A4 (8-1/2" x 11") size recycled paper.

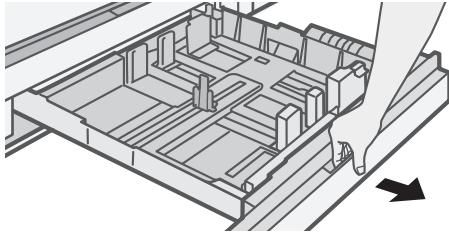

Gently pull out the paper tray.
If paper remains in the tray, remove it.

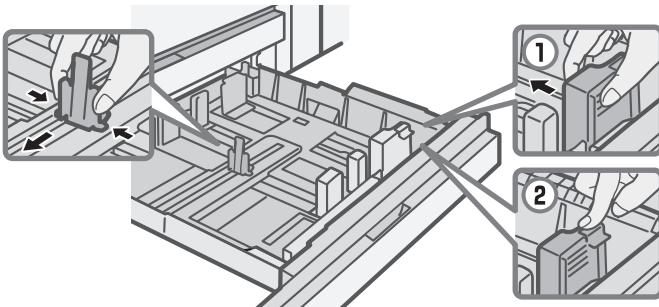

Move the two guides on the tray to change the size from B4 (8-1/2" x 14") to A4 (8-1/2" x 11").
If the paper you are loading is a non-standard size, lock the guides with ②.

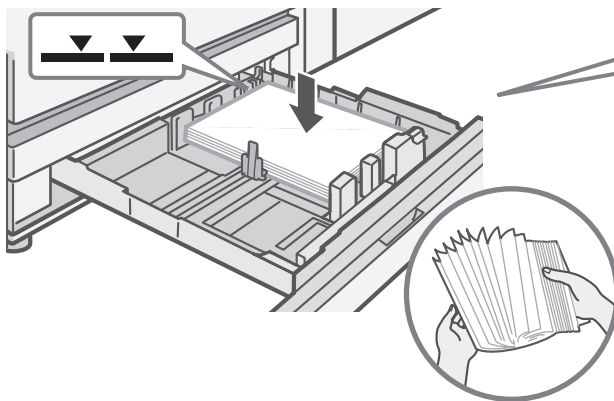

Insert the paper with the print side face down.
Fan the paper well before inserting it.
Otherwise, multiple sheets may feed at once and cause a misfeed.

 Indicator line
The indicator line indicates the maximum height of the paper that can be loaded in the tray. When loading paper, make sure that the stack is not higher than the indicator line.
Use both hands to place the paper from right overhead so that it does not fold.
Folds in the paper will cause misfeeds.

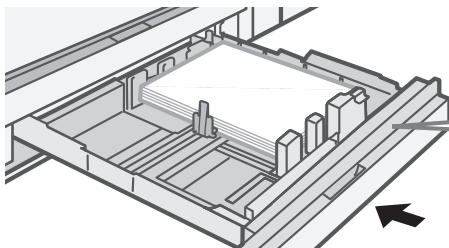

Gently push the tray into the machine.

Changing the tray settings

When you change the paper in a tray, the tray settings in the system settings must also be changed.

SYSTEM
SETTINGS



1 Press the [SYSTEM SETTINGS] key.

2 Configure the tray settings in the touch panel.

(1) Touch the [Paper Tray Settings] key.

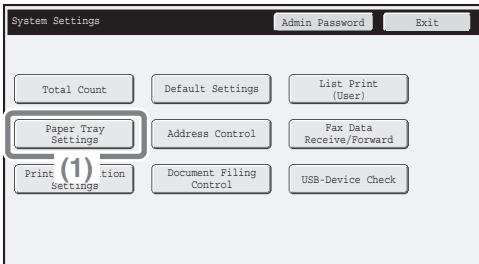

(2) Touch the [Tray Settings] key.



(3) Use the  key to display the tray settings of tray 4.

(4) Touch the [Change] key in "Tray 4".

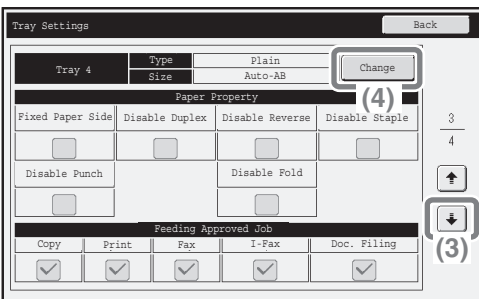

(5) Select [Recycled] from the "Type" select box.

(6) Make sure that [Auto-Inch] is selected in the "Size" select box.

For more information, see "PAPER TRAY SETTINGS" in the User's Guide.

(7) Touch the [OK] key.

The above steps change the paper settings for tray 4 to A4 recycled paper.

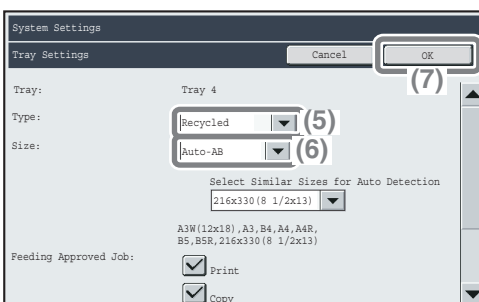

Loading paper in other trays

Tray 1 and Tray 2

To change the paper size of tray 1 and tray 2, see "TRAY SETTINGS FOR TRAY 1 AND TRAY 2" in the User's Guide.

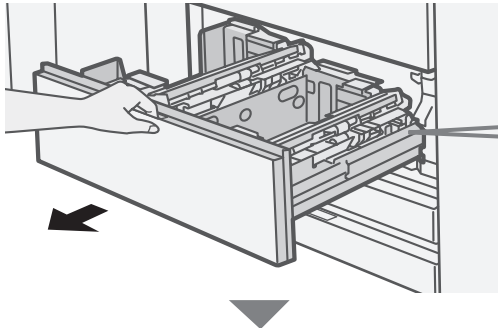

Gently pull out the paper tray.

Tray 1

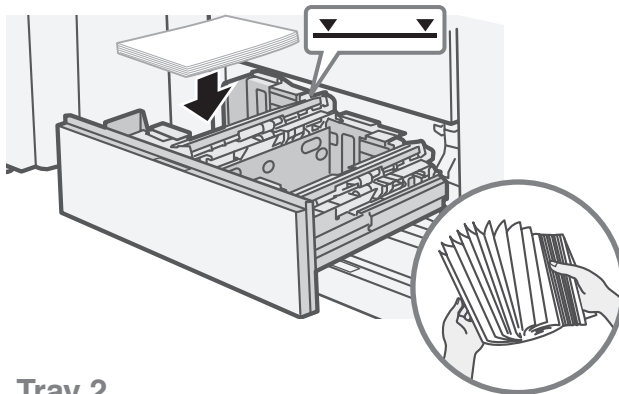



Tray 1
Raise the paper guide.
Insert the paper with the print side face down.

Tray 2
Raise the paper guide.
Insert the paper with the print side face down.

Return the paper guide to its original position after loading the paper. Fan the paper well before inserting it. Otherwise, multiple sheets may feed at once and cause a misfeed. Use both hands to place the paper from right overhead so that it does not fold. Folds in the paper will cause misfeeds.

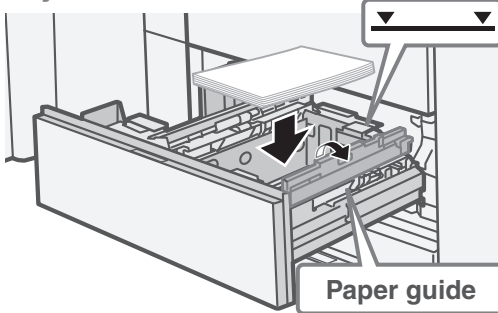
Tray 2



 **Indicator line**
The indicator line indicates the maximum height of the paper that can be loaded in the tray. When loading paper, make sure that the stack is not higher than the indicator line.

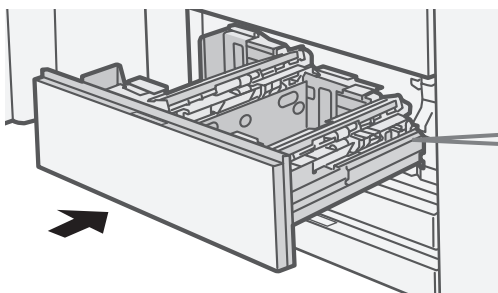

Gently push the tray into the machine.

Bypass tray (MX-MFX1)

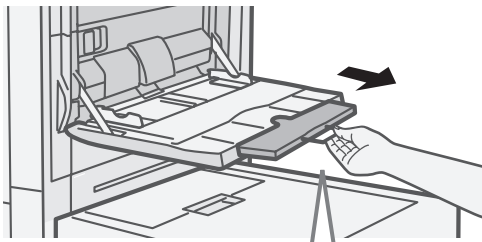
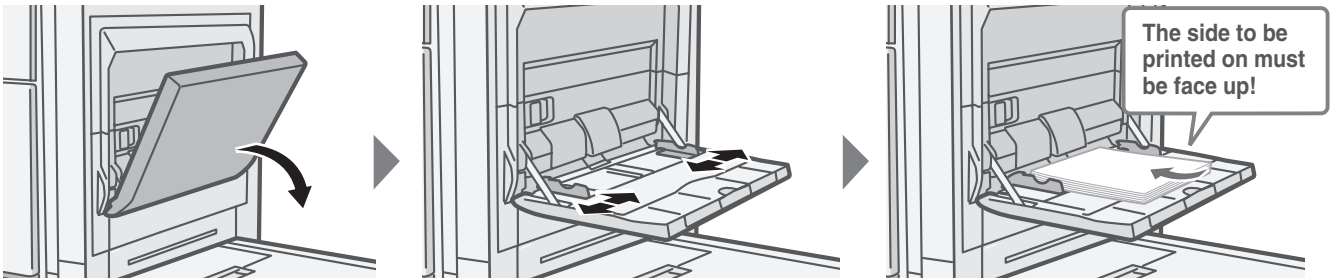

The maximum number of plain paper sheets that can be loaded in the bypass tray is about 100. When loading A3W, A3, B4 size paper, pull out the tray extension.

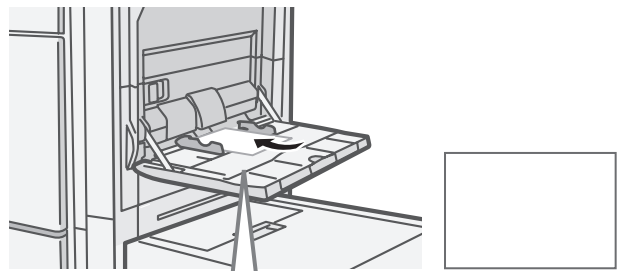

Place paper that is A5 (7-1/4" x 10-1/2") or smaller in the horizontal orientation.

Bypass tray (MX-MFX2)

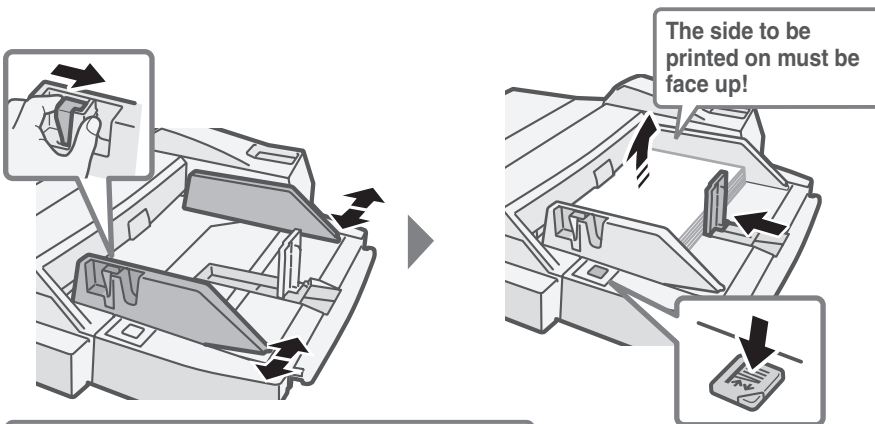

Squeeze the lever that locks the guide, and move the guide to the desired paper size.

The maximum number of plain paper sheets that can be loaded in the bypass tray is about 500. After loading paper, press the tray button and make sure that the paper rises. To remove paper from the tray, press this button, make sure that the paper descends, and then remove the paper. When loading paper larger than A4R or 8-1/2" x 11"R, pull out the extension tray. For details, see "Loading paper in the bypass tray (MX-MFX2)" in the User's Guide.

Special types of paper that cannot be loaded in other trays can be loaded in the bypass tray. For detailed information on the bypass tray, see "LOADING PAPER IN THE BYPASS TRAY" in the User's Guide.

Large capacity tray

MX-LCX6

The paper size of tray 5 can only be changed by a service technician.

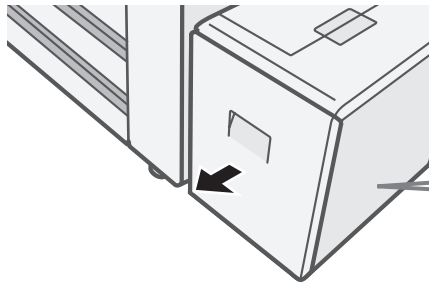

Gently pull out the paper tray.

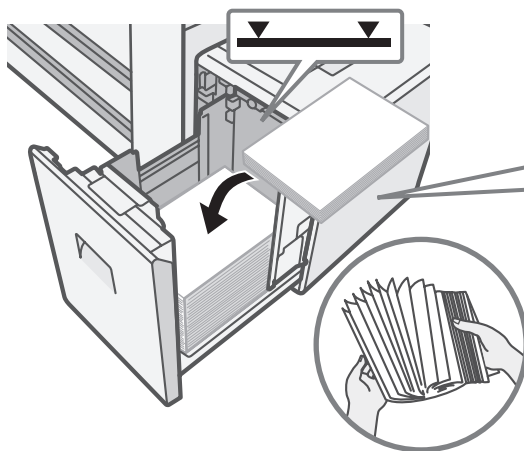

Insert the paper with the print side face up.
Fan the paper well before inserting it.
Otherwise, multiple sheets may feed at once and cause a misfeed.

▼ — ▼ Indicator line
The indicator line indicates the maximum height of the paper that can be loaded in the tray. When loading paper, make sure that the stack is not higher than the indicator line.

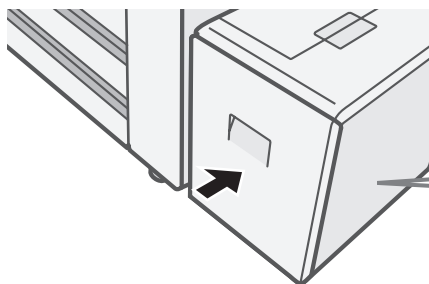

Gently push the tray into the machine.

MX-LCX3N

To change the paper size of tray 5, see "TRAY SETTINGS FOR THE LARGE CAPACITY TRAY (MX-LCX3N)" in the User's Guide.

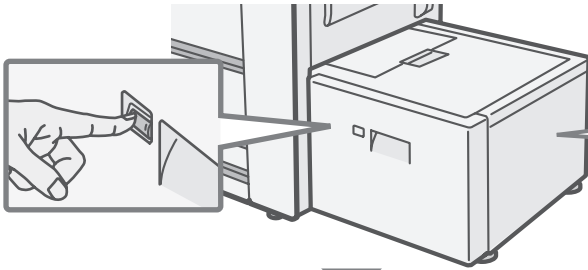

Before pulling the tray out, press the operation button. The operation button indicator will blink. Pull out the tray after the operation button indicator turns off.

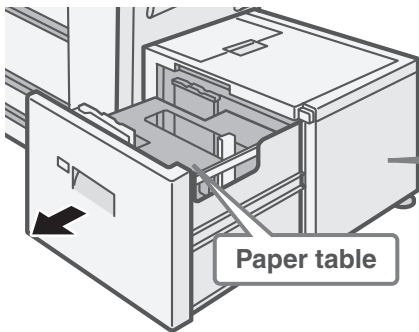

Gently pull out the paper tray.

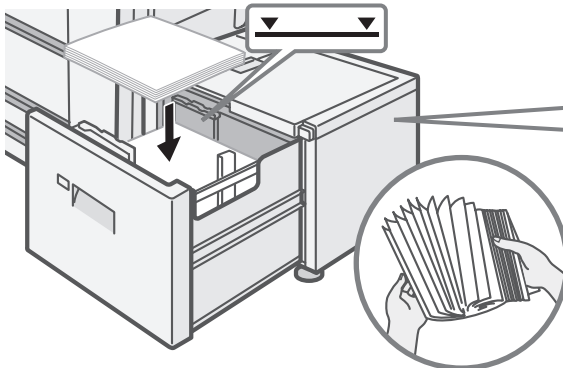

Insert the paper with the print side face up. When a certain amount of paper is placed on the paper table, the paper table will automatically descend slightly and then stop. Continue loading paper in this way. Fan the paper well before inserting it. Otherwise, multiple sheets may feed at once and cause a misfeed. Do not insert spare paper or other objects into openings inside the tray.

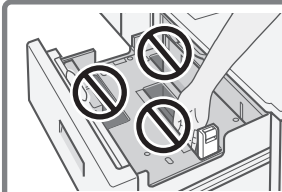

⚠ Warning

When placing paper, do not insert your fingers into the openings in the paper table.

Indicator line

The indicator line indicates the maximum height of the paper that can be loaded in the tray. When loading paper, make sure that the stack is not higher than the indicator line.

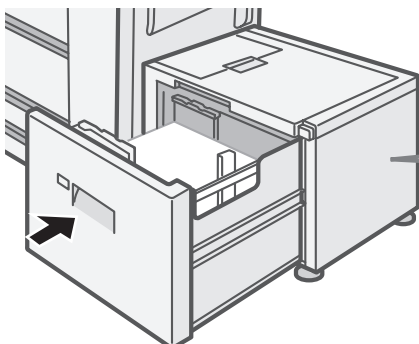

Gently push the tray into the machine. The operation button indicator will blink. Pull out the tray after the operation button indicator turns off.

Large capacity trays

MX-LCX4

To change the paper size of tray 5 and tray 6, see "TRAY SETTINGS FOR THE LARGE CAPACITY TRAYS (MX-LCX4)" in the User's Guide. The paper size of tray 7 can only be changed by a service technician.

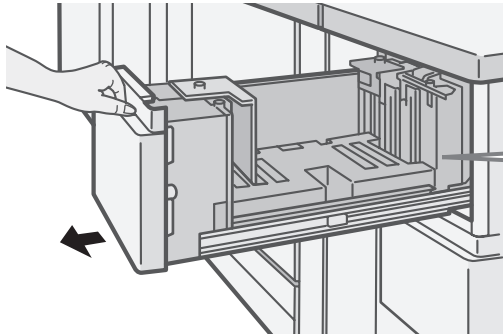

Gently pull out the paper tray.

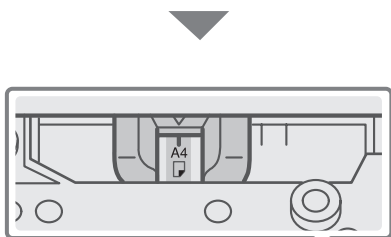

Make sure that the paper size selector knob is set to the size of paper you loaded.

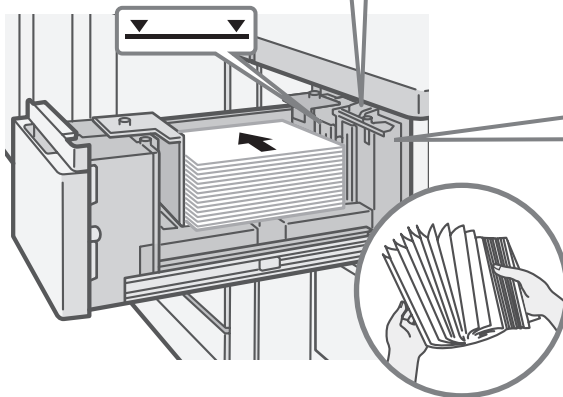

Insert the paper with the print side face up.
Up to 1000 sheets can be loaded in trays 5 and 6, and up to 2550 sheets can be loaded in tray 7.
Fan the paper well before inserting it. Otherwise, multiple sheets may feed at once and cause a misfeed.

▼ — ▼ Indicator line
The indicator line indicates the maximum height of the paper that can be loaded in the tray. When loading paper, make sure that the stack is not higher than the indicator line.

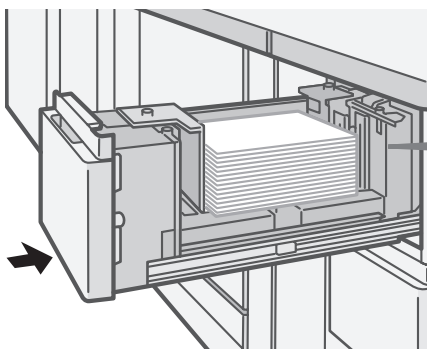

Gently push the tray into the machine.

MX-LCX5

To change the paper size of tray 5, tray 6 and tray 7, see "TRAY SETTINGS FOR THE LARGE CAPACITY TRAYS (MX-LCX5)" in the User's Guide.

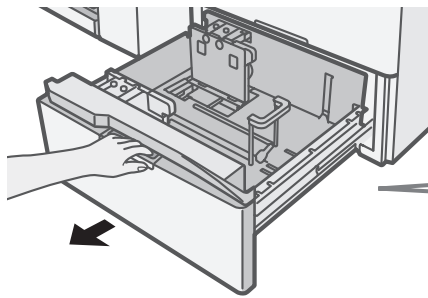

Gently pull out the paper tray.

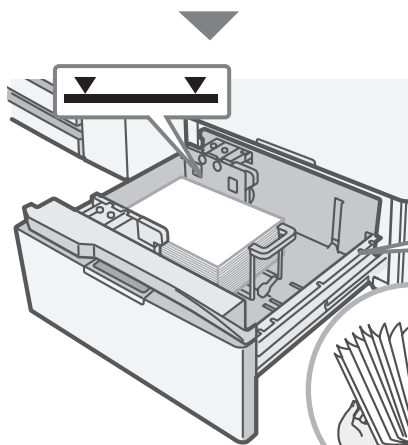

Insert the paper with the print side face up.
Up to 1000 sheets can be loaded in trays 5 and 7, and up to 2000 sheets can be loaded in tray 6.
Fan the paper well before inserting it. Otherwise, multiple sheets may feed at once and cause a misfeed.

▼——▼ Indicator line

The indicator line indicates the maximum height of the paper that can be loaded in the tray. When loading paper, make sure that the stack is not higher than the indicator line.

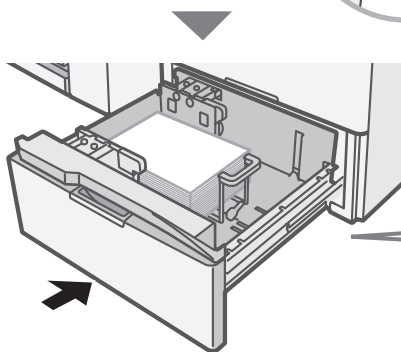

Gently push the tray into the machine.

Inserter

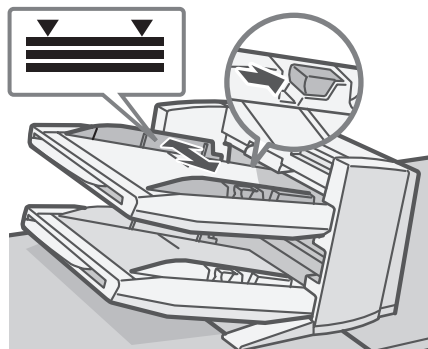

Squeeze the lever that locks the guide, and move the guide to the desired paper size.

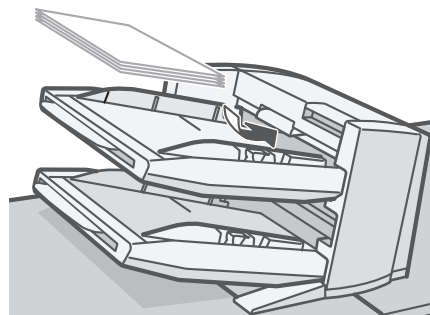

FINISHING

Depending on the options that have been installed, you can staple or punch holes in copy, print, and manual finishing output.

This section explains the types of output finishing that can be performed. For the procedures for using these functions, see the Copier Guide, Printer Guide, and User's Guide.

Sort function

This sorts the output into collated sets.

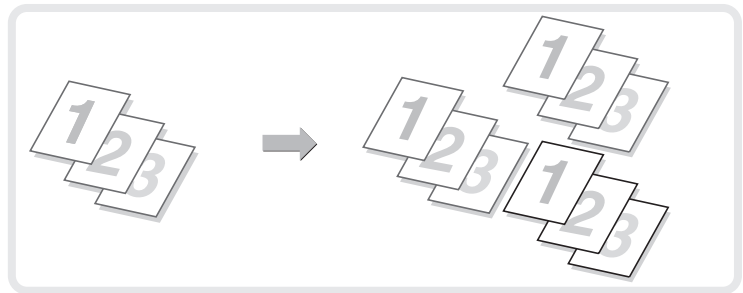

Group function

This groups output by page.

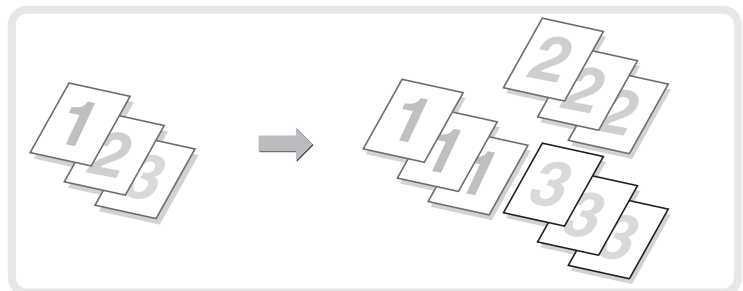

Offset function

This offsets each set of output from the previous set, making it easy to remove output from the tray.

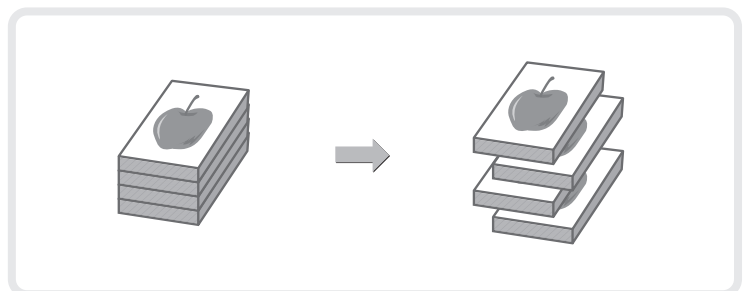

Staple sort function

This function sorts output into sets and staples each set.

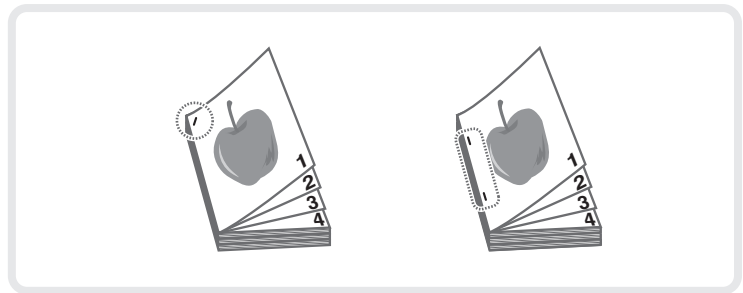

Pamphlet staple function

This function staples each set of output in two places along the centreline and folds the output to create a pamphlet.

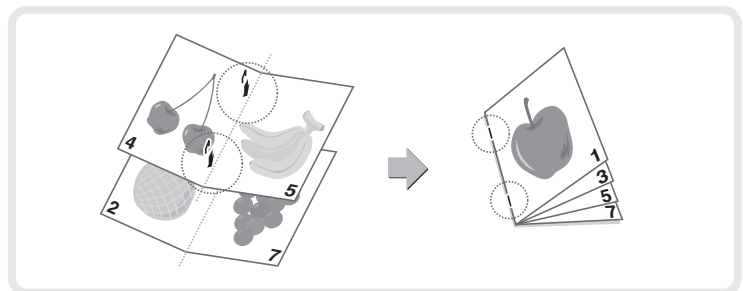

Punch function

This function punches holes in output.

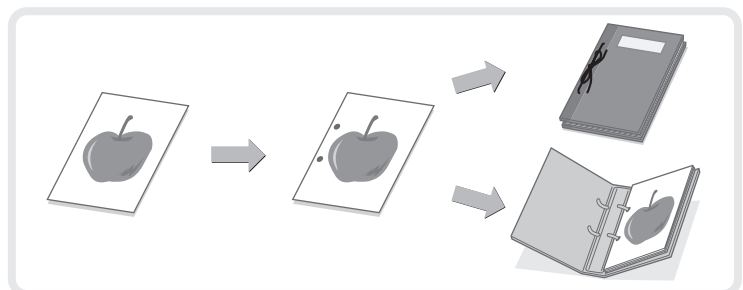

Folding function

This can be used to fold output in half, and to fold back a folded side.

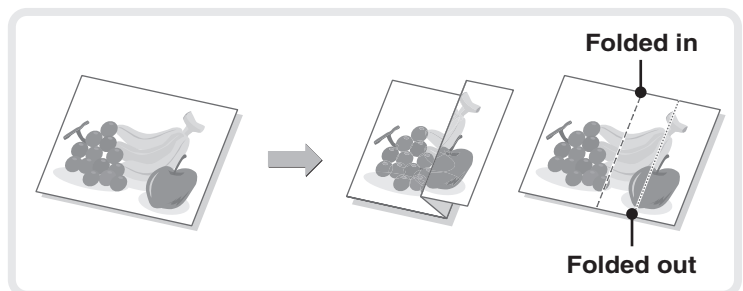

Copying

This section explains the basic procedures for using the copier function. This section also introduces the various types of copying that can be performed using the special modes.

▶ BASE SCREEN OF COPY MODE	28
▶ MAKING COPIES	29
▶ 2-SIDED COPYING (Automatic Document Feeder) . .	30
▶ COPYING ON SPECIAL PAPER (Bypass Copy)	31
▶ SELECTING THE EXPOSURE AND IMAGE TYPE . . .	33
▶ FITTING THE COPY IMAGE TO THE PAPER (Automatic Ratio Selection)	34
▶ ENLARGEMENT/REDUCTION (Preset Ratios / Zoom) . .	36
▶ CHECKING COPIES BEFORE PRINTING (Proof Copy) . .	38
▶ FINISHING	40
▶ INTERRUPTING A COPY RUN (Interrupt Copy)	41
▶ STORING COPY OPERATIONS (Job Programs)	42
▶ SPECIAL MODES	44
▶ SELECTING A SPECIAL MODE	45
▶ CONVENIENT COPY FUNCTIONS	46

BASE SCREEN OF COPY MODE

Touch the [COPY] key in the touch panel to open the base screen of copy mode.
Select copy settings in the base screen.

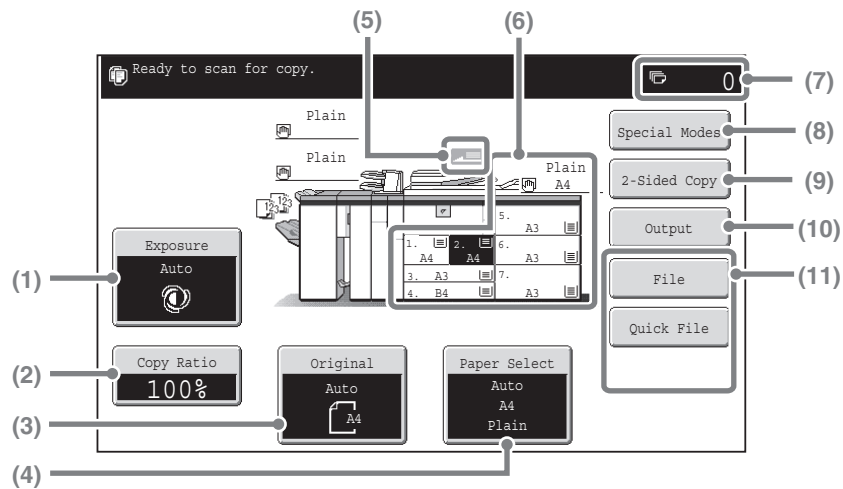

(1) [Exposure] key

This shows the current copy exposure and exposure mode settings. Touch this key to change the exposure or exposure mode setting.

(2) [Copy Ratio] key

This shows the current copy ratio. Touch this key to adjust the copy ratio.

(3) [Original] key

Touch this key to enter the original size manually. When an original is placed, this key shows the automatically detected original size. If the original size is set manually, the set size appears.

(4) [Paper Select] key

Touch this key to change the paper (tray) that is used. The tray, paper size, and paper type will appear. The tray images in the paper size display can be touched to open the same screen.

(5) Original feed display

This appears when an original is inserted in the automatic document feeder.

(6) Paper select display

This shows the size of paper loaded in each tray and the amount of paper remaining . The selected tray is highlighted.

(7) Number of copies display

This shows the number of copies set.

(8) [Special Modes] key

Touch this key to select special modes such as Margin Shift, Erase, and Dual Page Copy.

(9) [2-Sided Copy] key

Touch this key to select the 2-sided copying function.

(10) [Output] key

Touch this to select an output function such as sort, group, offset, staple sort, saddle stitch, punch, or folding.

(11) Customized keys

The keys that appear here can be changed to show settings or functions that you prefer.

MAKING COPIES

This is the most basic procedure for making copies.

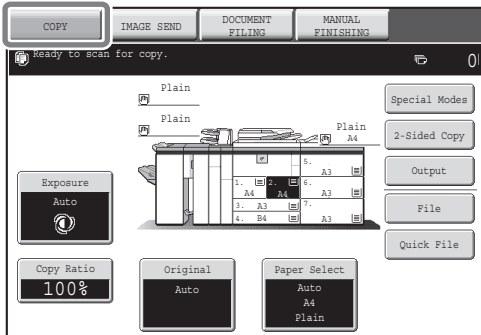
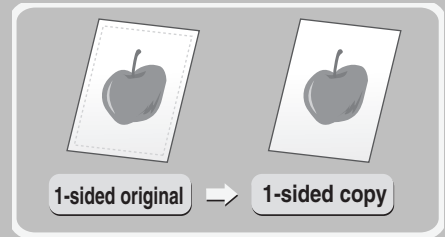

- 1 Touch the [COPY] key.**
The base screen of copy mode appears.

The side to be scanned must be face up!



- 2 Place the originals.**
When using the document glass, place the original with the side to be scanned face down.

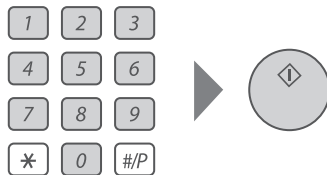

- 3 Set the number of copies and then press the [START] key.**

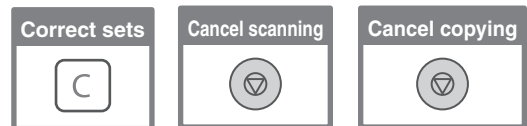

2-SIDED COPYING (Automatic Document Feeder)

You can use the automatic document feeder to make automatic 2-sided copies without the bother of manually turning the originals over and re-inserting them. This section explains how to copy 1-sided originals onto both sides of the paper.

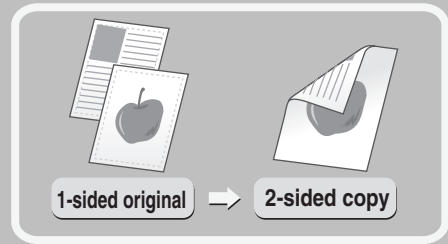

The side to be scanned must be face up!



1 Place the originals.

2 Select settings in the touch panel.

(1) Touch the [2-Sided Copy] key.

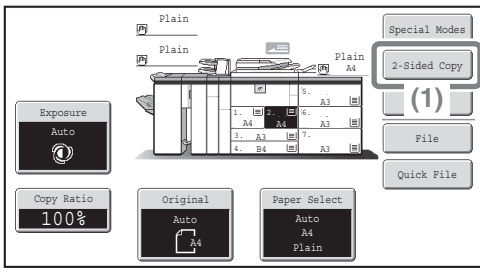

(2) Touch the [1-Sided to 2-Sided] key.

(3) Touch the [OK] key.

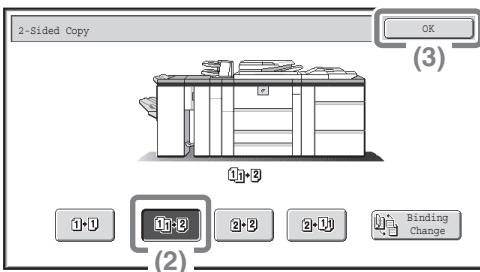

3 Set the number of copies and then press the [START] key.

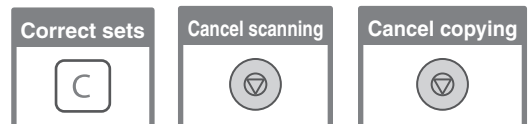
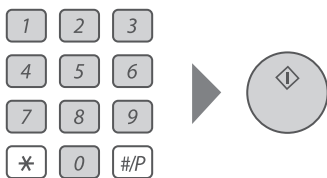

COPYING ON SPECIAL PAPER (Bypass Copy)

Use the bypass tray to copy on special media such as heavy paper, envelopes, and tab paper. This section explains how to load A4 recycled paper in the bypass tray.

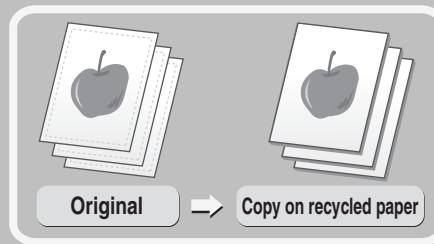

The side to be scanned must be face up!



1 Place the originals.

When using the document glass, place the original with the side to be scanned face down.

The side to be copied on must be face up!

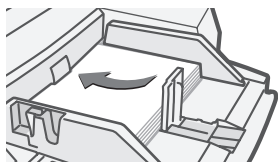

2 Insert paper in the bypass tray.

After loading paper, press the tray button and make sure that the paper rises. For details, see "Bypass tray (MX-MFX2)" (page 20).

3 Select settings in the touch panel.

(1) Touch the [Paper Select] key.

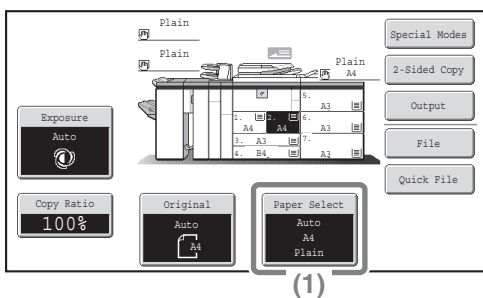

(1)

(2) Touch the paper type key of the bypass tray. Here the [Plain] key has been touched.

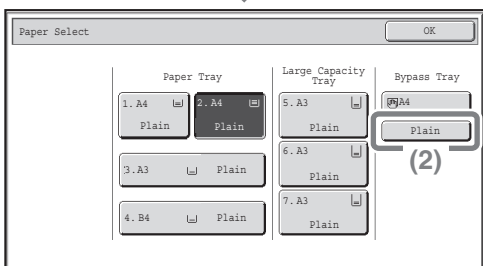

(2)

(3) Touch the [Recycled] key.

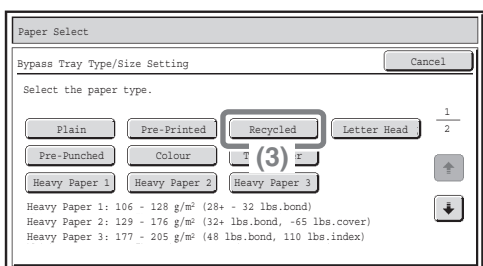

Select settings in the touch panel. (Continued)

(4) Touch the [Auto-AB] key.

(5) Touch the [OK] key.

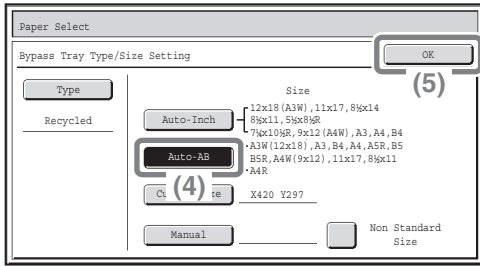

(6) Touch the bypass tray key.

(7) Touch the [OK] key.

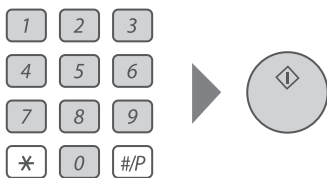
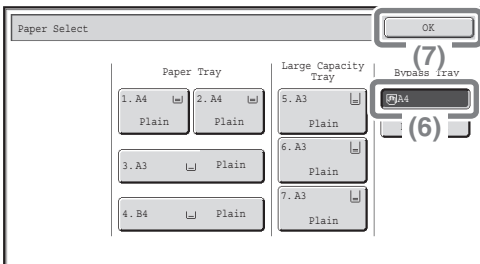

4 Set the number of copies and then press the [START] key.

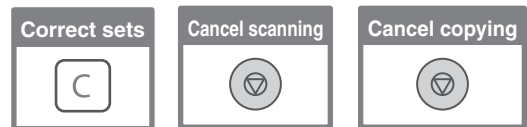

Selecting a tray

To select paper, touch the [Paper Select] key or the image of the machine in the base screen of copy mode.

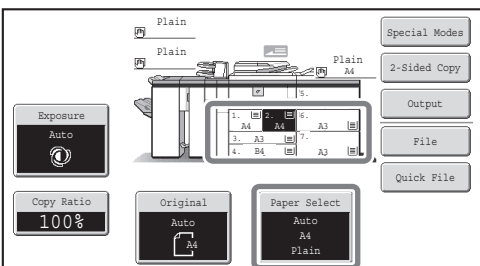

Touch a key to select a tray.

(A) Touch to select one of trays 1 to 4.

(B) Touch to select the bypass tray.

(C) Touch to set the type of paper in the bypass tray.

(D) Touch to select tray 5 to 7 (large capacity tray / large capacity trays).

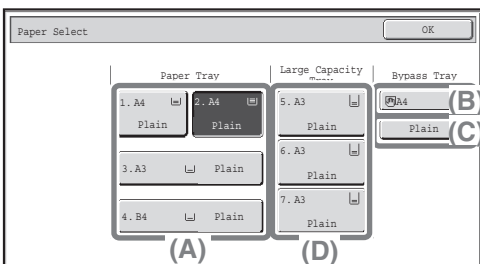

SELECTING THE EXPOSURE AND IMAGE TYPE

You can specify the original image type to obtain a clearer copy. The example of copying an original with light colours such as pencil writing is explained below.

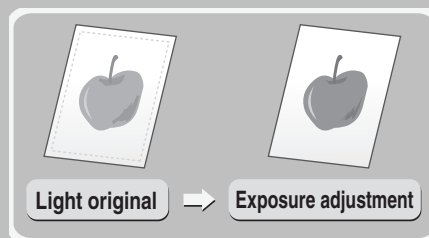

The side to be scanned must be face up!



1 Place the originals.

When using the document glass, place the original with the side to be scanned face down.

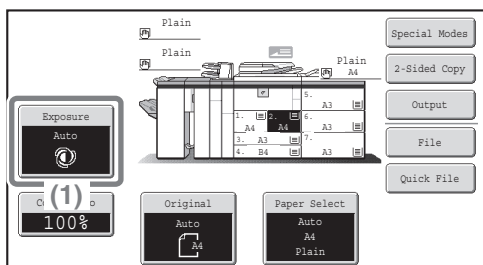

2 Select settings in the touch panel.

(1) Touch the [Exposure] key.

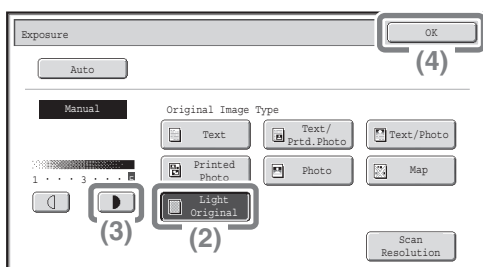

(2) Touch the [Light Original] key.

(3) Darken the printed result with the key. Nine levels are available for the exposure. Darken light originals with the key, and lighten dark originals with the key.

(4) Touch the [OK] key.

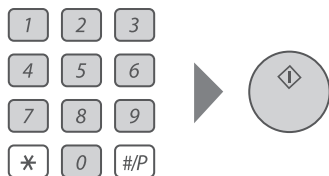

3 Set the number of copies and then press the [START] key.

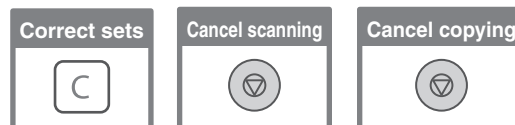

FITTING THE COPY IMAGE TO THE PAPER (Automatic Ratio Selection)

You can copy an original onto any size of paper using automatic enlargement/reduction.
This section explains how to copy an A4 original onto A3 paper.

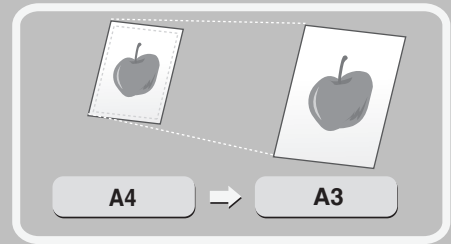

The side to be scanned must be face up!



1 Place the originals.

When using the document glass, place the original with the side to be scanned face down.

2 Select settings in the touch panel.

(1) Touch the [Paper Select] key.

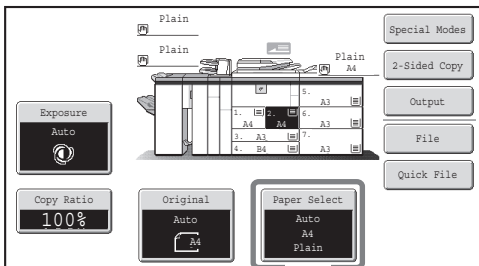

(1)

(2) Touch the tray that has the desired paper size.

(3) Touch the [OK] key.

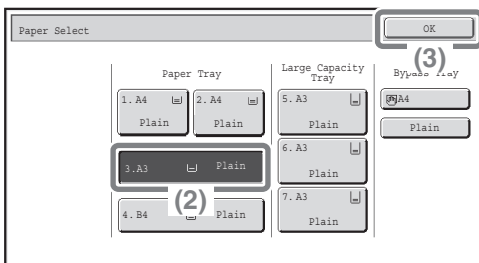

(4) Touch the [Auto Image] key.

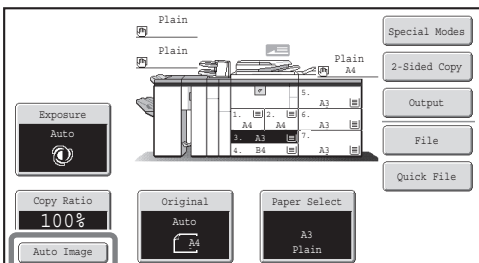

(4)

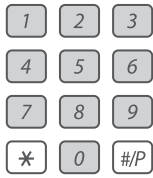

3 Set the number of copies.



4 Press the [START] key.

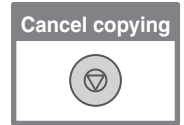
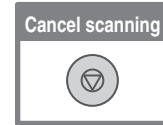

ENLARGEMENT/REDUCTION (Preset Ratios / Zoom)

For precise adjustment of the copy size, you can select a preset ratio and/or adjust the ratio in increments of 1%.
As an example, this section explains how to reduce the image to 55%.

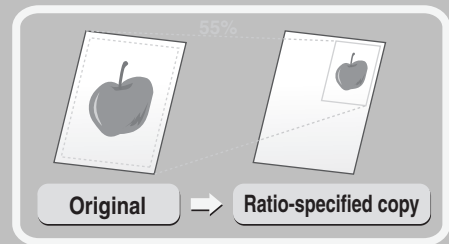

The side to be scanned must be face up!



1 Place the originals.

When using the document glass, place the original with the side to be scanned face down.

2 Select settings in the touch panel.

(1) Touch the [Copy Ratio] key.

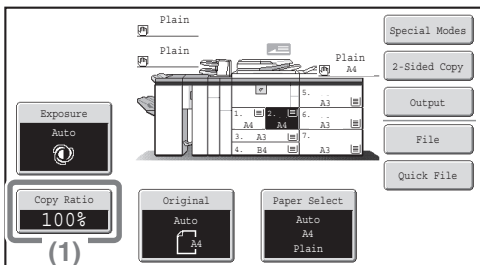

(2) Touch the [↓] key.

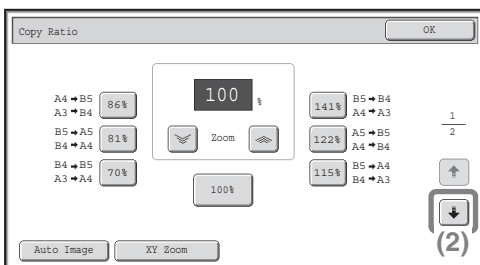

(3) Touch the [50%] key.

Touch the preset ratio key that is closest to 55% (the desired ratio).

(4) Set the copy ratio to 55% with the [Zoom] key.

The [Zoom] key decreases the ratio in increments of 1%, and the [Zoom] key increases the ratio in increments of 1%.

(5) Touch the [OK] key.

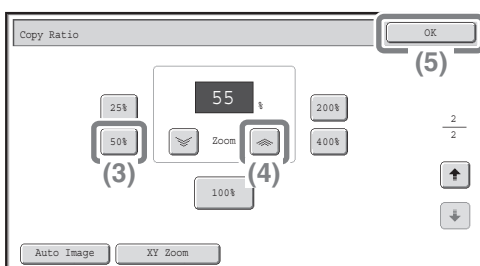

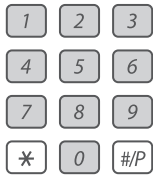

3 Set the number of copies.



4 Press the [START] key.

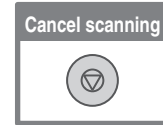

CHECKING COPIES BEFORE PRINTING (Proof Copy)

Regardless of the number of copies specified, this function initially prints only the first set. After you have checked the first set, the remaining sets are printed.

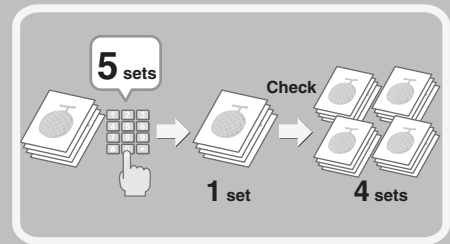

The side to be scanned must be face up!



1 Place the originals.

When using the document glass, place the original with the side to be scanned face down.

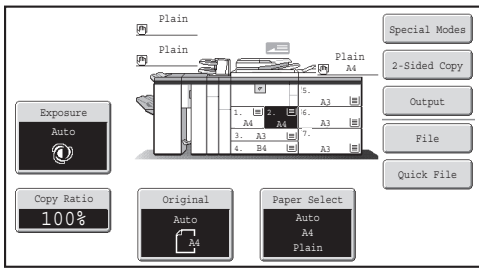

2 Select copy settings.



3 Set the number of copies.

PROOF COPY



4 Press the [PROOF COPY] key.

One set of copies is printed.

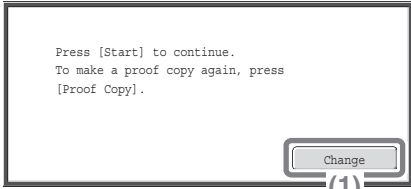

5 Change the settings.

(1) Touch the [Change] key.

If there are no problems in the proof copy, go to step 7.

(2) Touch the appropriate keys to change the settings.

(3) Touch the [OK] key.

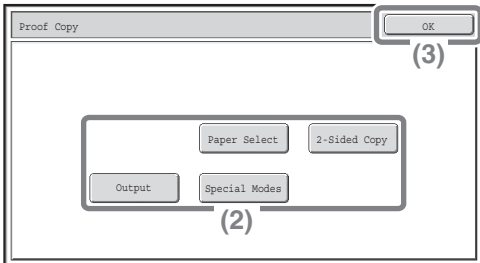

PROOF COPY



6 Press the [PROOF COPY] key.

One set of copies will be printed using the settings you changed in step 5. If you need to make further changes to the settings, repeat steps 5 and 6.

7 Press the [START] key.

The number of sets of copies set in step 3 minus one set will be printed.

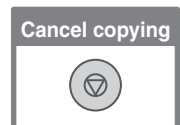
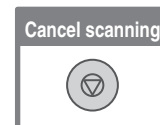

FINISHING

You can touch the [Output] key to select output functions such as the sort function, group function, and offset function, and to select the output tray. All settings that can be selected when the finisher, punch unit, saddle unit, and folding unit are installed are explained.

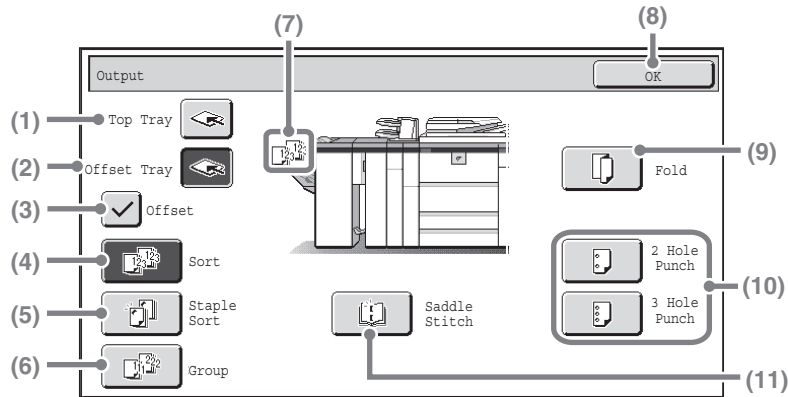

(1) [Top Tray] key

Output is delivered to the top tray. When the top tray is selected, the offset, staple sort, and saddle stitch functions cannot be used.

(2) [Offset Tray] key

Output is delivered to the offset tray. When the [Staple Sort] key is selected, the [Offset Tray] key is automatically selected.

(3) [Offset] key

This is used to offset each set of output from the previous set. The offset function operates when the checkbox is selected and does not operate when the checkbox is not selected .

(4) [Sort] key

This is used to sort (collate) output into sets.

(5) [Staple Sort] key

This is used to sort output into sets, staple each set, and deliver the sets to the tray. (Note that the sets will not be offset in the output tray.) When this function is selected, three keys will appear for selecting the staple position.

(6) [Group] key

This is used to group copies by page.

(7) Output display

An icon will appear to indicate the output mode.

(8) [OK] key

Touch this key to close the output screen and return to the base screen.

(9) [Fold] key

This folds the output in half.

(10) [2 Hole Punch] key, [3 Hole Punch] key

Holes can be punched in output.

(11) [Saddle Stitch] key

This is used to staple and fold each set of copies at the centreline.

INTERRUPTING A COPY RUN (Interrupt Copy)

When the machine is printing, you can temporarily interrupt the job and perform a copy job that you wish to prioritize. This feature is useful when you need to make an urgent copy during a long copy run.

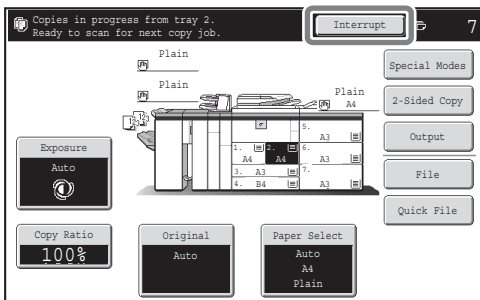
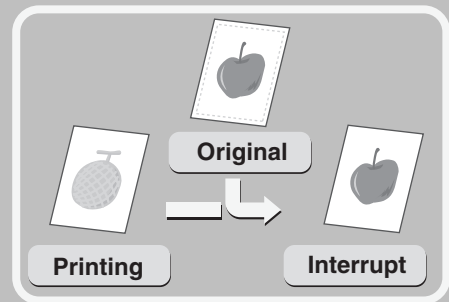

1 Touch the [Interrupt] key while the machine is printing.

The [Interrupt] key appears in the base screen while the machine is printing.

The side to be scanned must be face up!



2 Place the originals.

When using the document glass, place the original with the side to be scanned face down.

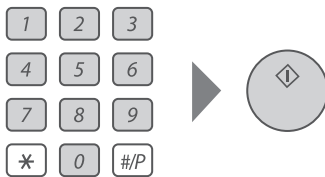

3 Set the number of copies and then press the [START] key.

The interrupted copy job will resume when the copy job is finished.

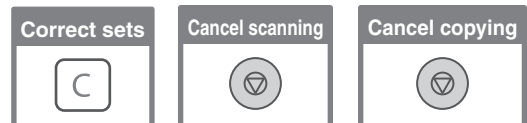

STORING COPY OPERATIONS (Job Programs)

You can store a group of copy settings. The settings can be retrieved and used whenever needed. When you frequently use the same group of settings, this saves you the trouble of manually selecting the settings each time you need to use them.

Storing a job program



- 1 Press the [# / P] key ()

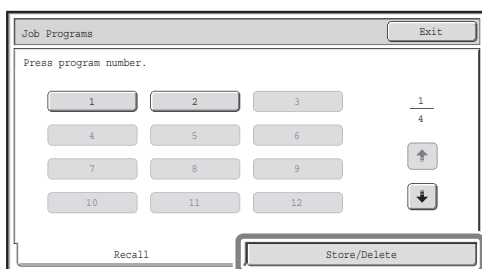

(1)

- 2 Select settings in the touch panel.

- (1) Touch the [Store/Delete] tab.

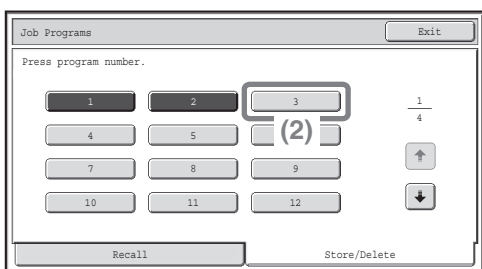

(2)

- (2) Touch the key in which you want to store a job program.

Touch any key that is not highlighted.

Keys that have a job program stored are highlighted.

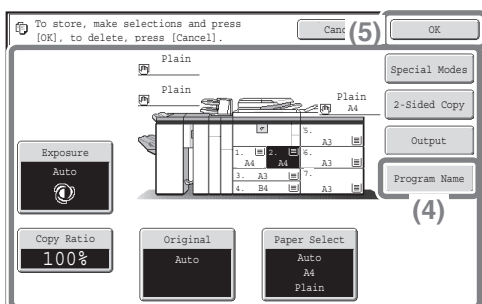

(3)

- (3) Select the copy settings that you wish to store.

- (4) Touch the [Program Name] key.

A text entry screen appears. Enter a name for the program (max. of 10 characters). For the procedure for entering text, see "7. ENTERING TEXT" in the User's Guide.

- (5) Touch the [OK] key.

Using a job program



- 1 Press the [# / P] key ()

Place the original.

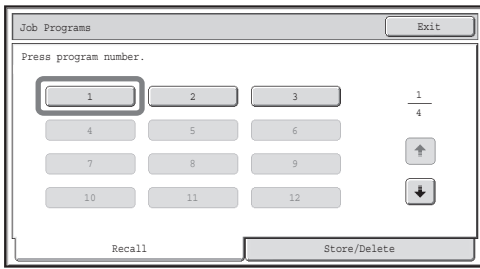

2 Touch the key of the desired job program.

After selecting the job program, set the number of copies and press the [START] key to begin copying.

Deleting a job program



1 Press the [#/P] key ($\boxed{\#/P}$).

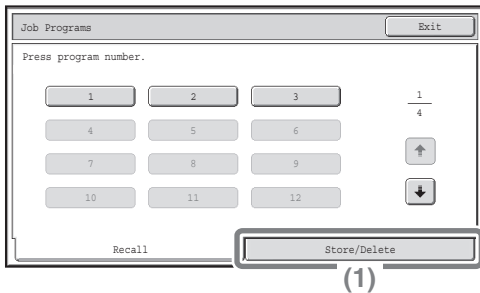

2 Select settings in the touch panel.

(1) Touch the [Store/Delete] tab.

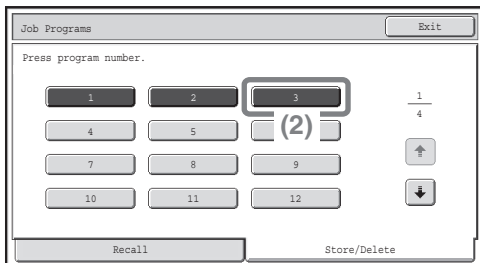

(2) Touch the key of the job program that you wish to delete.

Touch a key that is highlighted.

Keys that have a job program stored are highlighted.

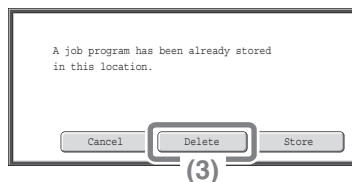

(3) Read the displayed message and touch the [Delete] key.

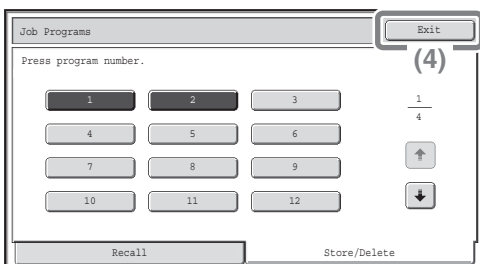

(4) Touch the [Exit] key.

SPECIAL MODES

The special modes can be used for a variety of special-purpose copy jobs.

This section introduces the types of copies that can be made with the special modes. (The procedures for using each special mode are not explained.)

Each special mode has its own settings and steps, however, the basic procedure is the same for all modes. The basic procedure for selecting a special mode is explained on the next page using "Margin Shift" as an example.

For the procedures for using the special modes, see "3. SPECIAL MODES" in the Copier Guide.

Special modes

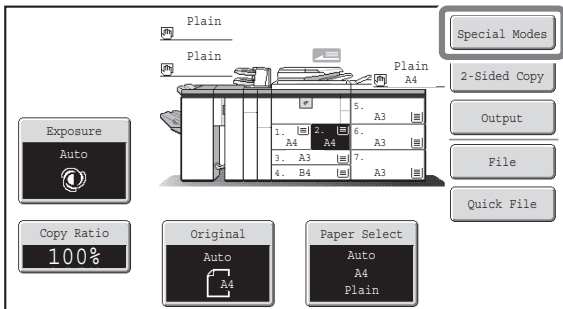

To use a special mode, open the special modes menu and touch the key of mode that you wish to use. The menu consists of two screens. Use the keys to switch between the screens. Touch the [Special Modes] key in the base screen to open the special modes menu.

1st screen

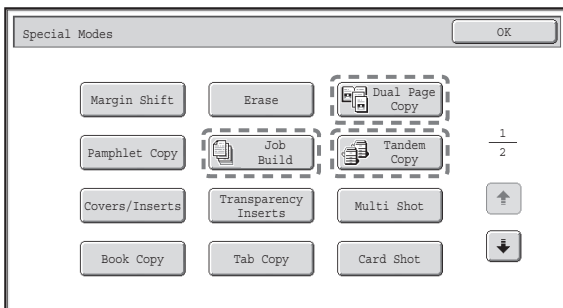

2nd screen

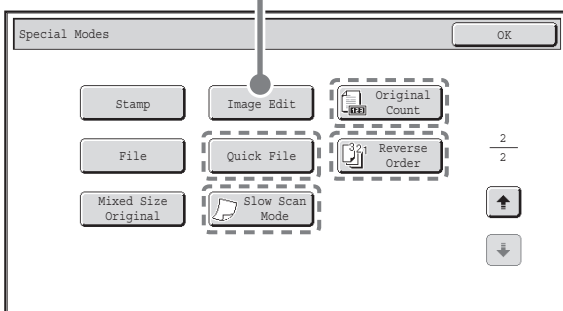
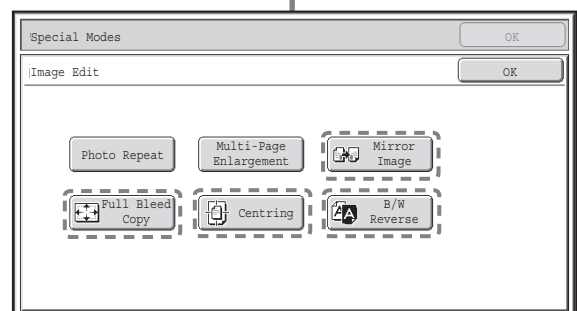

Image edit menu screen



When a special mode key encircled by is touched, the key is highlighted and the setting is completed. When any other special mode key is touched, a screen appears to let you select settings for that mode. The keys that appear vary by country and region and the peripheral devices that are installed.

SELECTING A SPECIAL MODE

The procedure for selecting settings for "Adding margins (Margin Shift)" is explained below as an example. Although the specific settings for each special mode vary, the general procedure is the same.

The side to be scanned must be face up!



1 Place the originals.

When using the document glass, place the original with the side to be scanned face down.

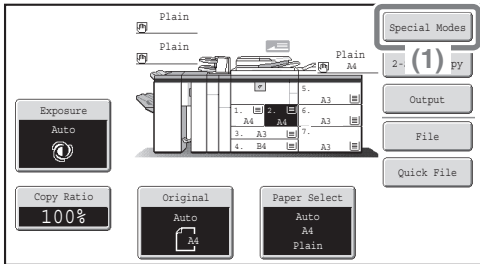

2 Select settings in the touch panel.

(1) Touch the [Special Modes] key.

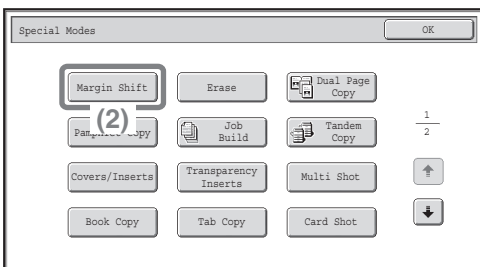

(2) Touch the [Margin Shift] key.

Shifting the left margin by 15 mm will be explained as an example.

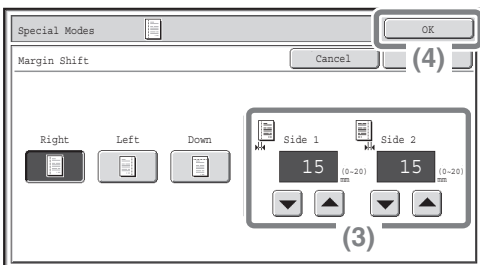

(3) Select 15 mm for the front side and 15 mm for the reverse side using the \downarrow \uparrow keys.

The margin shift position is initially set to "Right". To change the position to "Left" or "Down", touch the corresponding key.

(4) Touch the [OK] key.

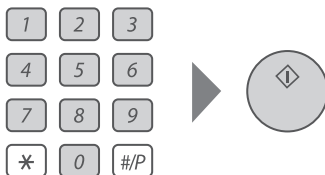

3 Set the number of copies and then press the [START] key.

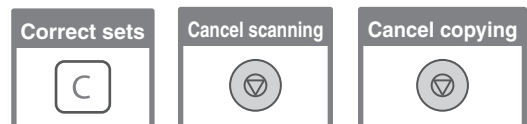

CONVENIENT COPY FUNCTIONS

Adding margins (Margin Shift)

Use this function to shift the image on the copy to create binding margins. This function is convenient when you will be binding the copies with a string or placing them in a binder.

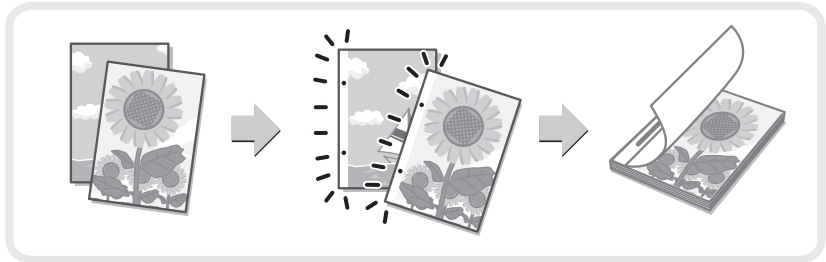

Erasing peripheral shadows (Erase)

Use this function to erase peripheral shadows that occur when making copies of books and other thick originals.

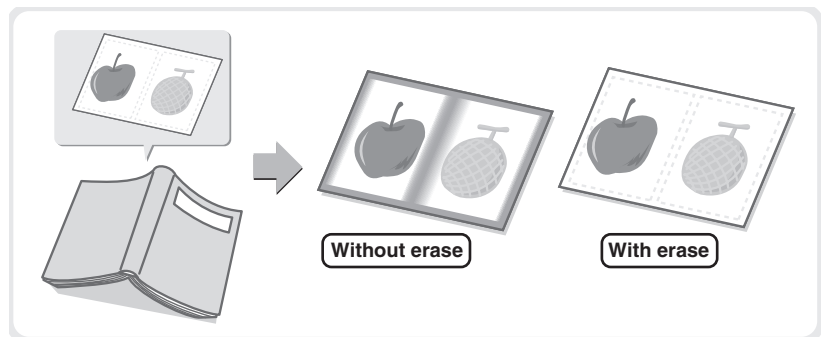

Copying each facing page of a bound document (Dual Page Copy)

Use this function to make separate copies of the left and right pages of a bound document such as a pamphlet. In addition, two facing pages can be copied to each side of one sheet of paper.

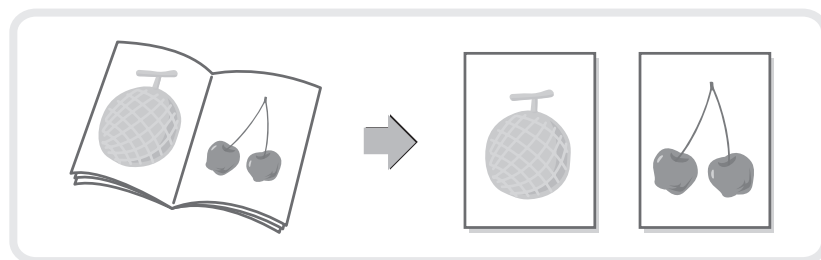

Making copies in pamphlet format (Pamphlet Copy)

Use this function to make copies that can be folded into a pamphlet. Pamphlet copy makes it easy to create pamphlets. When a saddle unit or a saddle stitch finisher is installed, the output is automatically folded at the centre and stapled.

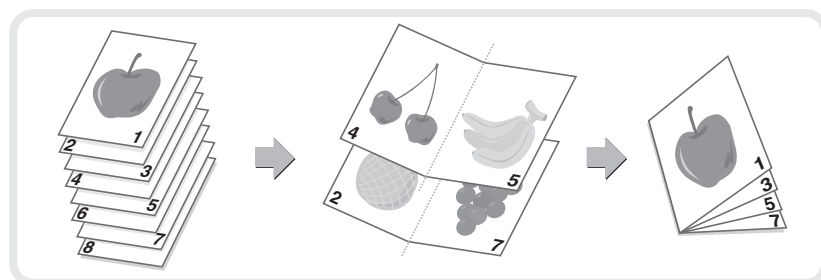

Copying a large number of originals at once (Job Build)

A stack of originals higher than the indicator line on the automatic document feeder cannot be fed through the feeder.

The job build function lets you divide the stack of originals into sets, feed each set, and copy the sets as a single job.

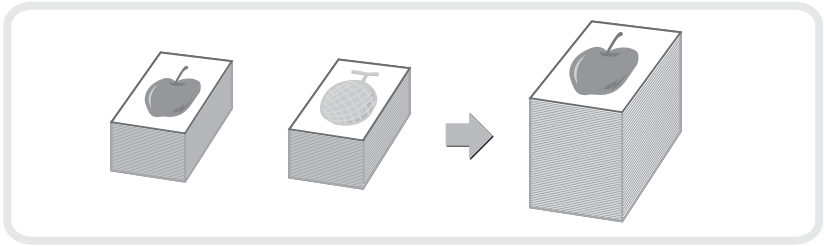

Using two machines to make a large number of copies (Tandem Copy)

You can divide a copy job between two machines connected to the same network.

This saves considerable time when running a large copy job.

To use this function, the tandem connection setting must be configured in the system settings.

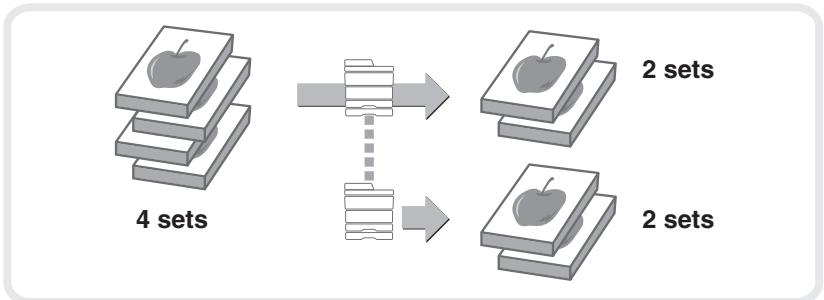

Using a different paper type for covers (Covers/Inserts)

This function enables you to use a different type of paper for the front and back covers of a set of copies.

A different type of paper can also be added as an insert at specified pages.

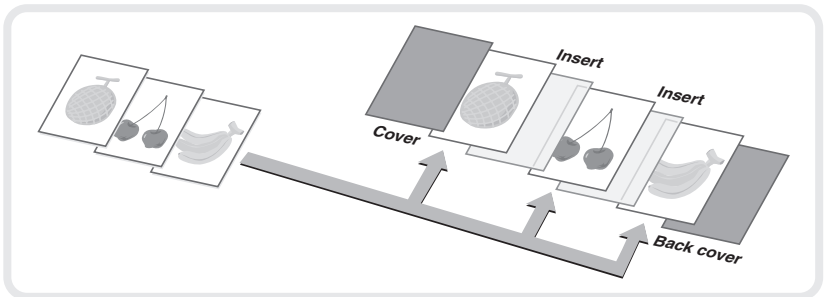

Adding inserts when copying on transparency film (Transparency Inserts)

When copying onto transparency film, this function inserts sheets of paper between the sheets of transparency film to keep them from sticking together.

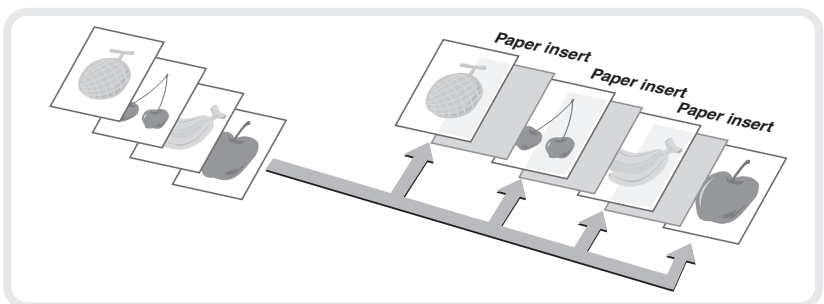

Copying multiple pages onto one sheet of paper (Multi Shot)

Use this function to copy two or four original pages onto one sheet of paper.

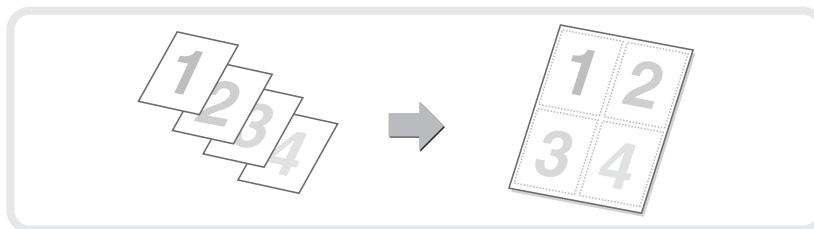

Copying a pamphlet (Book Copy)

Use this function to copy a book, pamphlet, or other bound original. The copies will be arranged in the same pamphlet-style layout.

When a saddle unit or a saddle stitch finisher is installed, the output is automatically folded at the centre and stapled.

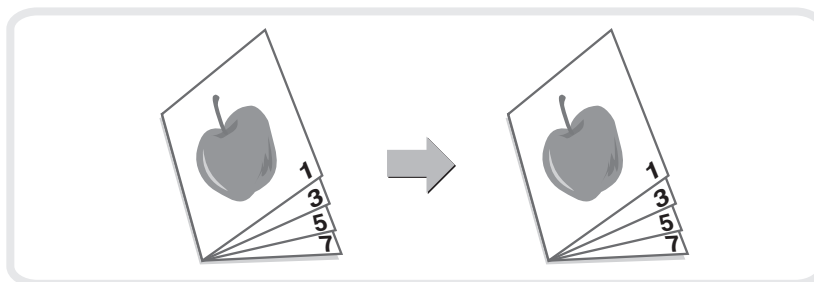

Copying captions onto tab paper (Tab Copy)

Use this function to copy captions onto the tabs of tab paper.

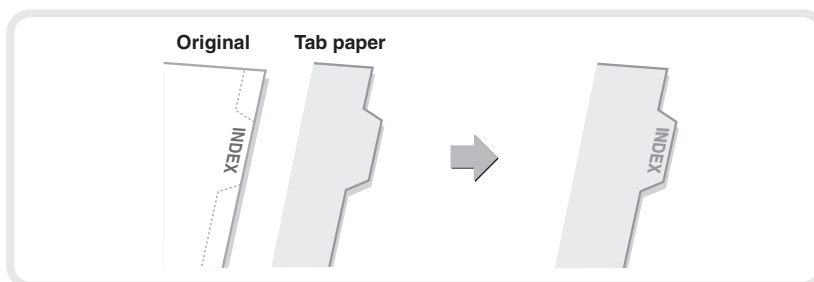

Copying both sides of a card onto one sheet of paper (Card Shot)

Use this function to copy the front and reverse side of a card onto one sheet of paper.

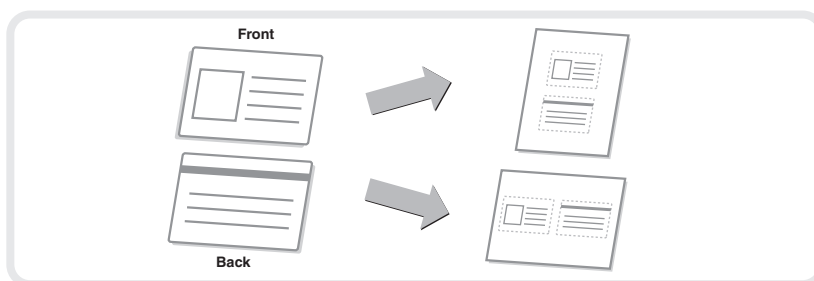

Printing the date or a stamp on copies (Stamp)

Use this function to print the date, a stamp, the page number, or text on copies.

The selected items will be printed on the copies.

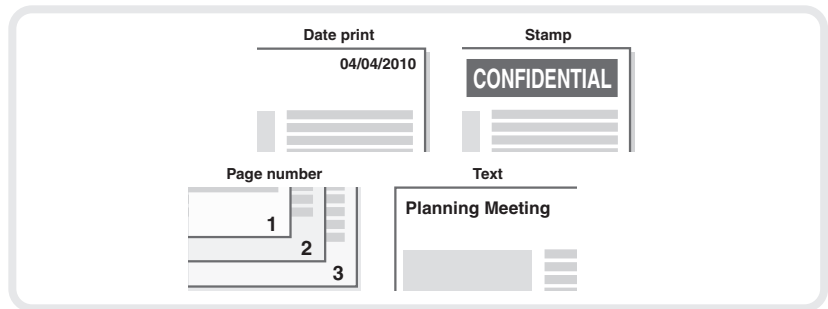

Repeating photos on a copy (Photo Repeat)

Use this function to print up to 24 copies of one photo on one sheet of paper.

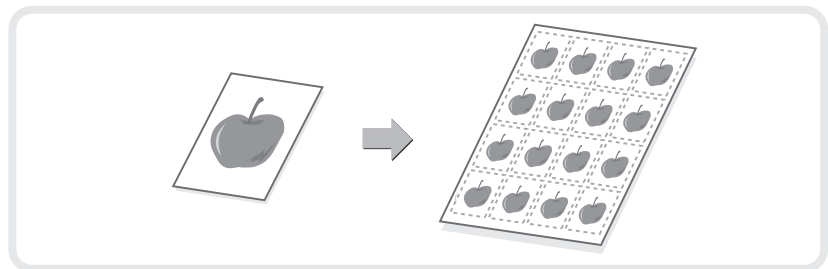

Creating a large poster (Multi-Page Enlargement)

Use this function to enlarge a copy image and print it using multiple sheets of paper. The sheets of paper can be attached together to form one large copy.

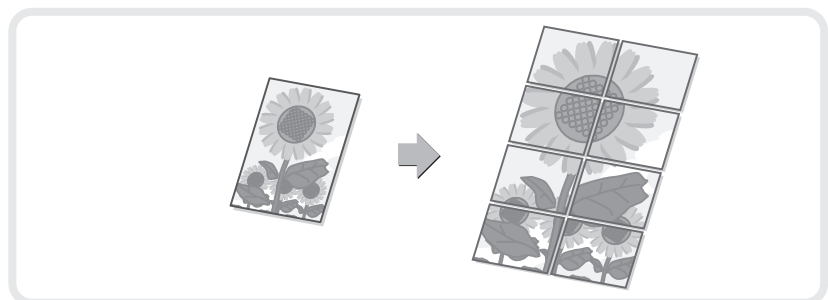

Inverting the image (Mirror Image)

Use this function to make a copy that is a mirror image of the original.

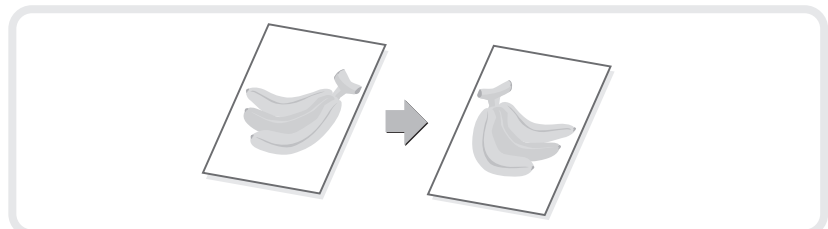

Copying an original without cutting off the edges (Full Bleed Copy)

You can make a full-size copy on paper larger than the original to ensure that the edges of the image are not cut off.

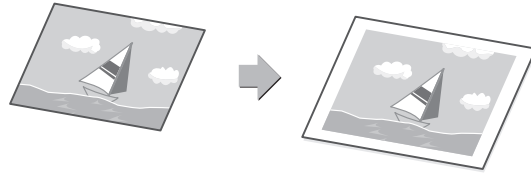

Copying in the centre of the paper (Centring)

Use this function to position the copy image at the centre of the paper. This is convenient when the image is reduced or copied onto paper that is larger than the original.

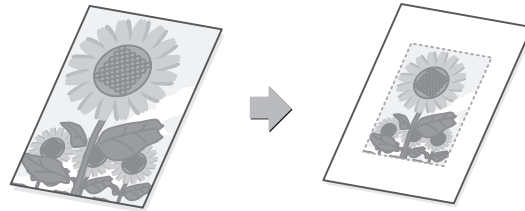

Reversing white and black in a copy (B/W Reverse)

This function reverses black and white in a copy to create a negative image. Use this function to save toner when copying an original with large black areas.

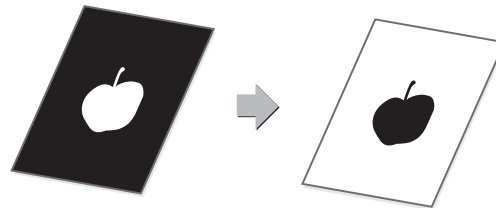

Checking the number of scanned original sheets before copying (Original Count)

The number of scanned original sheets can be counted and displayed before copying is executed. By allowing you to check the number of original sheets that were scanned, this helps reduce the occurrence of copy mistakes.

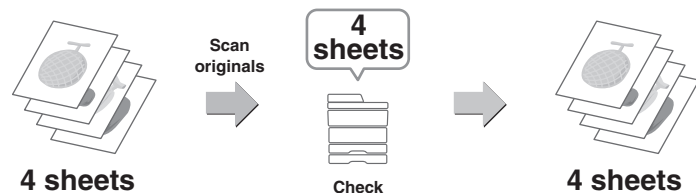

Copying in reverse order (Reverse Order)

With normal copying, the copies are delivered face down in order beginning from the first page, which means that the copies are in the same order as the pages of the original. When reverse order copying is used, the copies are delivered face up in order beginning from the first page, which means that the copies are in the reverse order of the original pages.

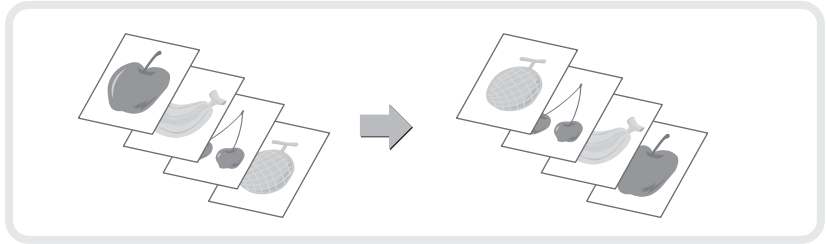

Copying originals that are different sizes (Mixed Size Original)

For example, even when a B5 original is mixed in with A4 originals, this function lets you copy all originals at once.

When used in combination with the auto image function, the copies can all be printed on the same size of paper.

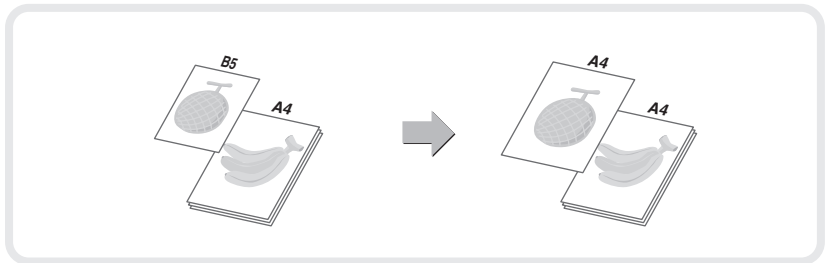

Copying thin originals (Slow Scan Mode)

This function lets you scan thin originals, which are normally difficult to handle, in the automatic document feeder.

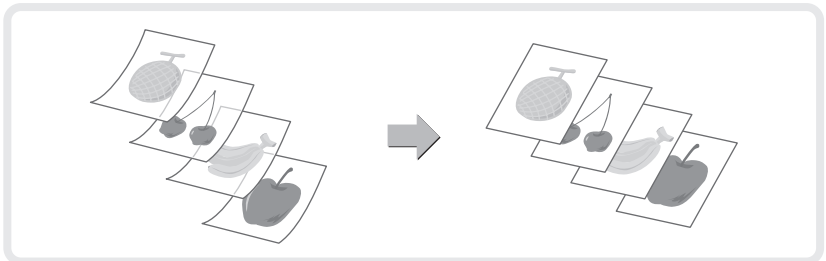

Printing

This section explains the basic procedure for printing using the printer driver of the machine. The settings that can be selected in the printer driver are also introduced.

The explanations of screens and procedures are primarily for Windows® XP in Windows® environments, and Mac OS X v10.4 (Mac OS 9.2.2 in the case of Mac OS 9) in Macintosh environments. The window varies depending on the operating system version, the printer driver version, and the application.

The printer expansion kit is required to use the printer function.

▶ PRINTING	54
▶ CANCELLING PRINTING (AT THE MACHINE)	61
▶ SELECTING PRINT SETTINGS	62
▶ CONVENIENT PRINTER FUNCTIONS	64

PRINTING

This section explains the basic procedures for printing.

Windows

The following example explains how to print an A4 size document from WordPad, which is a standard accessory program in Windows.

To install the printer driver and configure settings in a Windows environment, see "2. SETUP IN A WINDOWS ENVIRONMENT" in the Software Setup Guide.

For information on the available printer drivers and the requirements for their use, see "PRINTER FUNCTION OF THE MACHINE" in the Printer Guide.

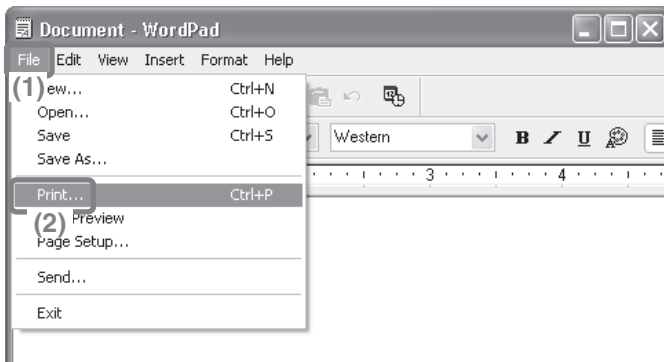

1 Select the print command in the application.

- (1) Open the [File] menu.
- (2) Select [Print].

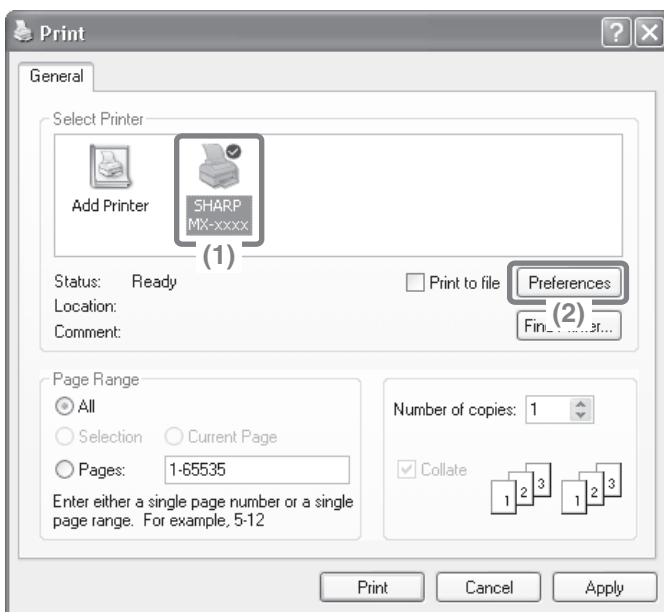

2 Open the printer driver properties window.

- (1) Select the printer driver of the machine.
- (2) Click the [Preferences] button.
In Windows 98/Me/NT 4.0, click the [Properties] button.
In Windows 2000, the [Preferences] button does not appear. Click the tabs in the "Print" dialog box to adjust the settings on the tabs.

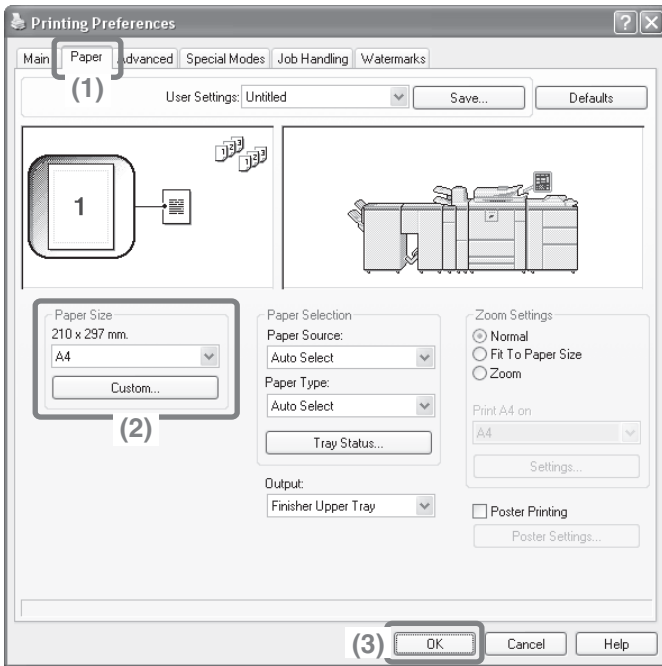

3 Select print settings.

- (1) Click the [Paper] tab.
- (2) Select [A4].
- (3) Click the [OK] button.

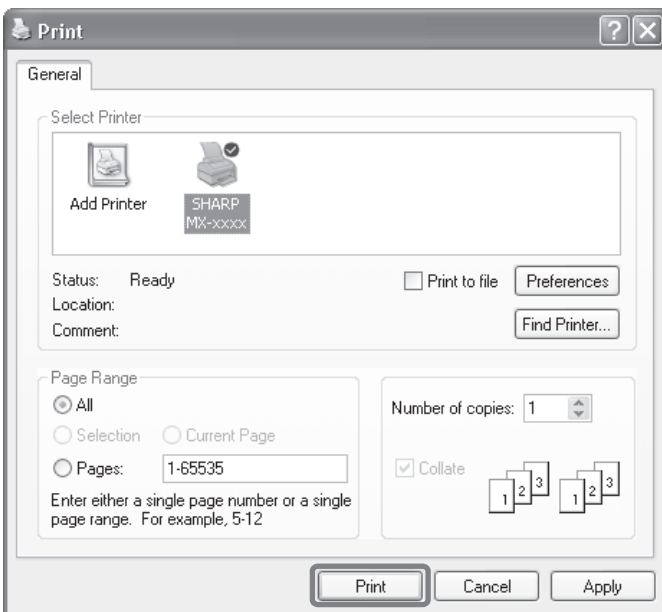

4 Click the [Print] button.

Printing begins.

In Windows 98/Me/NT 4.0, click the [OK] button.

Using printer driver help

When selecting settings in the printer driver properties window, you can display Help to view explanations of the settings. (Only in Windows)

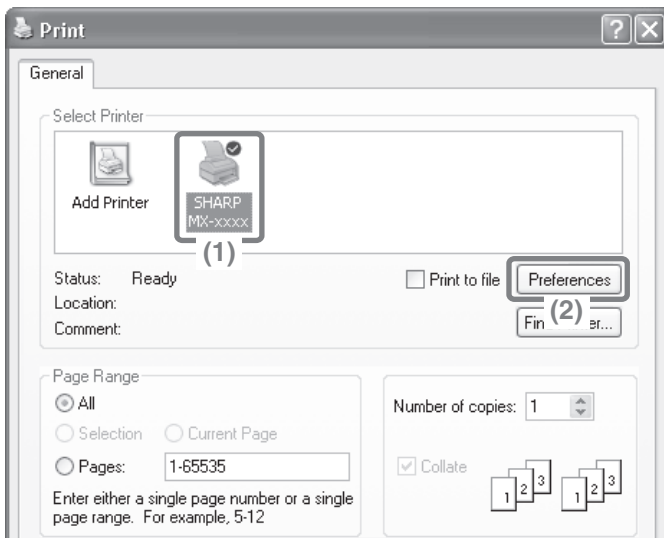

1 Open the printer driver properties window.

(1) Select the printer driver of the machine.

(2) Click the [Preferences] button.

In Windows 98/Me/NT 4.0, click the [Properties] button.

In Windows 2000, the [Preferences] button does not appear. Click the tabs in the "Print" dialog box to adjust the settings on the tabs.

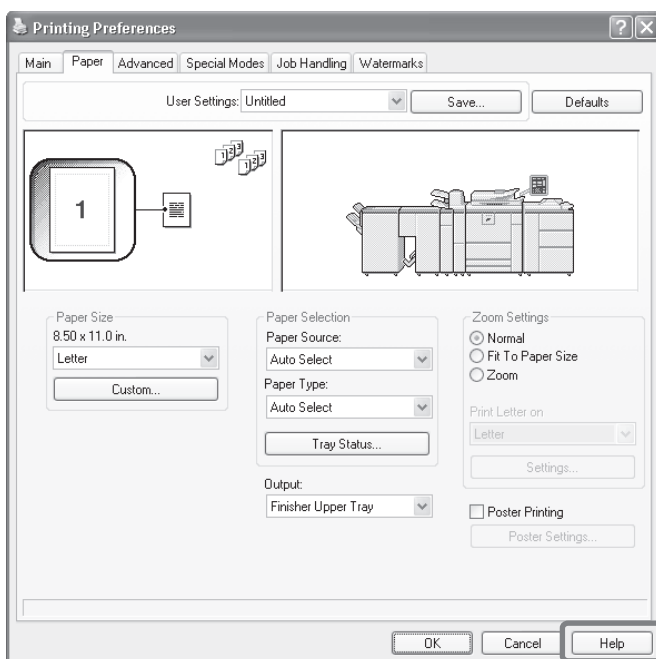

2 Click the [Help] button.

The Help window will open to let you view explanations of the settings on the tab.

To view Help for settings in a dialog box, click the underlined text at the top of the Help window.

To view Help for a specific setting

To view Help for a particular setting, click the  button in the upper right-hand corner of the window and then click the setting.

* In Windows Vista, move the cursor to the setting that you wish to learn about and press the [F1] key. Help for that setting will appear.

When the information icon () appears

The icon can be clicked to show prohibited combinations of functions and other information.

Macintosh

The following example explains how to print an A4 size document from "TextEdit" ("SimpleText" in Mac OS 9), which is a standard accessory program on Macintosh computers.

In a Macintosh environment, the printer expansion kit and PS3 expansion kit must be installed to use the machine as a network printer.

To install the printer driver and configure settings in a Macintosh environment, see "3. SETUP IN A MACINTOSH ENVIRONMENT" in the Software Setup Guide.

Setting the paper size

Select paper settings in the printer driver before selecting the print command.

MAC OS X

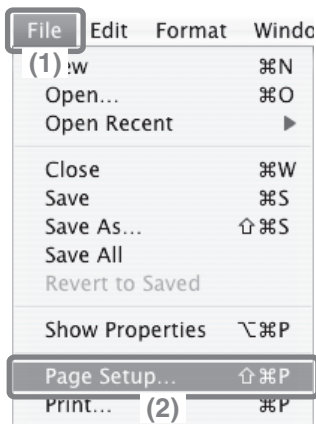

1 Open the page setup window in TextEdit.

- (1) Open the [File] menu.
- (2) Select [Page Setup].

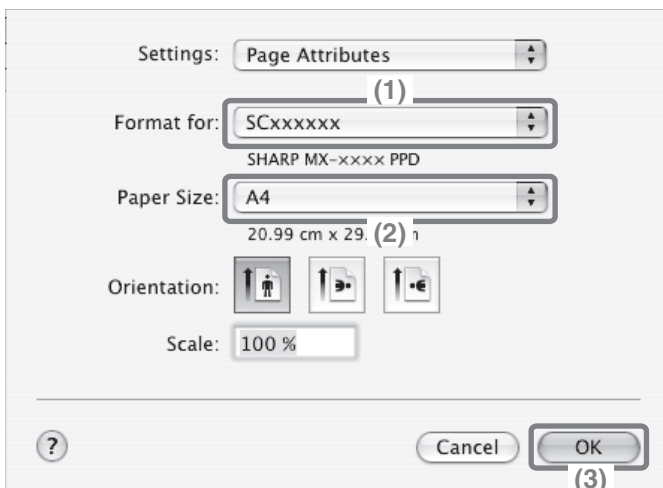

2 Select paper settings.

- (1) Make sure the correct printer is selected.

The machine name that appears in the "Format for" menu is normally [SCxxxxxx]. ("xxxxxx" is a sequence of characters that varies depending on your machine model.)

- (2) Select [A4].
- (3) Click the [OK] button.

MAC OS 9

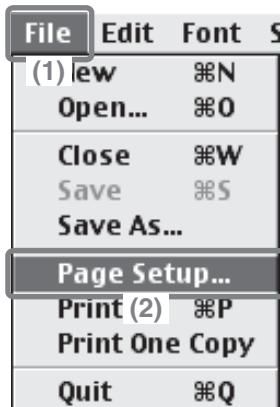

1 Open the page setup window in SimpleText.

- (1) Open the [File] menu.
- (2) Select [Page Setup].

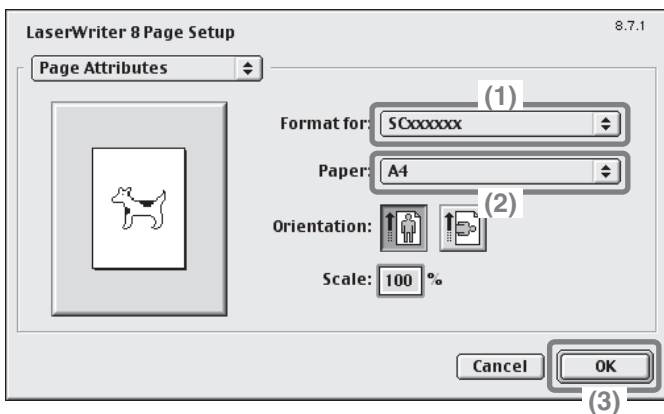

2 Select paper settings.

- (1) Make sure the correct printer is selected.

The machine name that appears in the "Format for" menu is normally [SCxxxxxx]. ("xxxxxx" is a sequence of characters that varies depending on your machine model.)

- (2) Select [A4].
- (3) Click the [OK] button.

Printing a file

MAC OS X

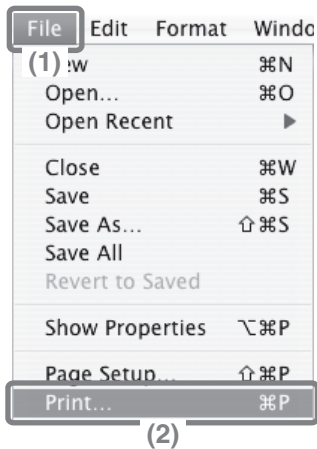

1 Execute printing from TextEdit.

- (1) Open the [File] menu.
- (2) Select [Print].

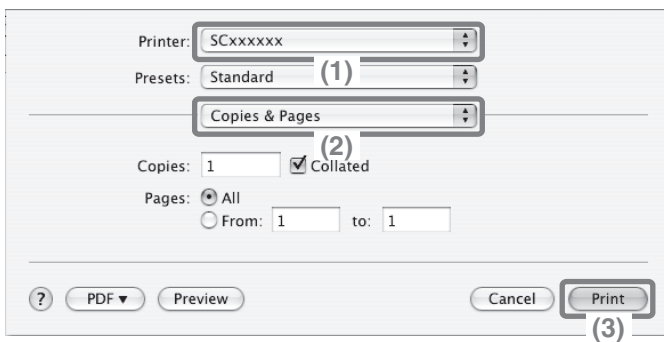

2 Select print settings and click the [Print] button.

- (1) Make sure the correct printer is selected.

The machine name that appears in the "Printer" menu is normally [SCxxxxxx]. ("xxxxxx" is a sequence of characters that varies depending on your machine model.)

- (2) Select print settings.

Click [⌵] next to [Copies & Pages] and select each setting that you wish to configure from the pull-down menu. The screen for the selected setting will appear.

- (3) Click the [Print] button.

Printing begins.

MAC OS 9

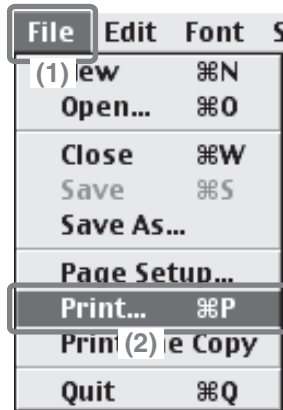

1 Execute printing from SimpleText.

- (1) Open the [File] menu.
- (2) Select [Print].

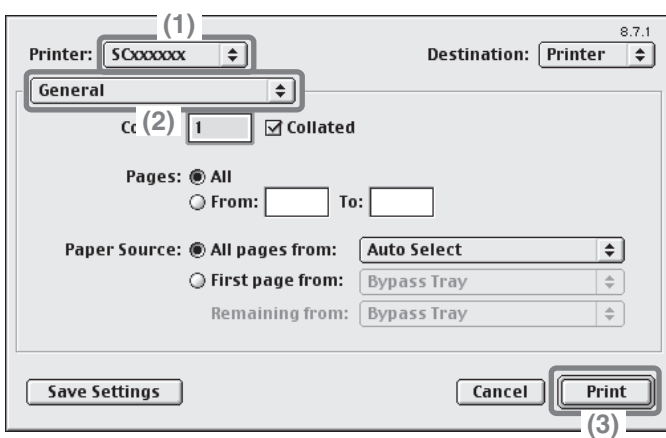

2 Select print settings and click the [Print] button.

(1) Make sure the correct printer is selected.

The machine name that appears in the "Printer" menu is normally [SCxxxxxx]. ("xxxxxx" is a sequence of characters that varies depending on your machine model.)

(2) Select print settings.

Click [General] next to [General] and select each setting that you wish to configure from the pull-down menu. The screen for the selected setting will appear.

(3) Click the [Print] button.

Printing begins.

CANCELLING PRINTING (AT THE MACHINE)

You can cancel a print job if you cancel before printing actually begins.

JOB STATUS



1 Press the [JOB STATUS] key.

2 Select settings in the touch panel.

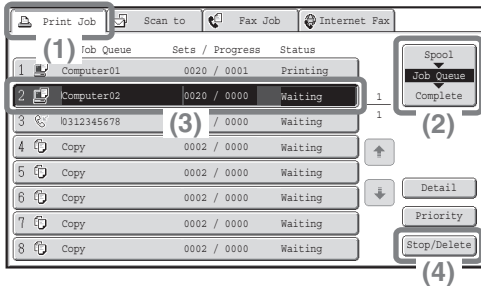

(1) Touch the [Print Job] tab.

(2) Change the print job status mode to [Spool] or [Job Queue].

Touch this key to change modes. The selected mode will be highlighted.

(3) Touch the key of the print job that you wish to cancel.

(4) Touch the [Stop/Delete] key.

(5) Touch the [Yes] key.

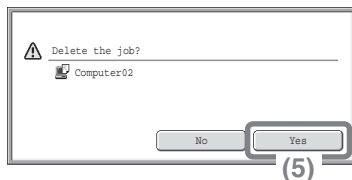

SELECTING PRINT SETTINGS

To use the print function of the machine, the settings in the printer driver properties window must be configured. See "PRINTING" (page 54) for the procedure for opening the printer driver properties window and the basic procedure for printing.

Windows

The procedure for selecting settings in the printer driver is explained below using "Fitting the print image to the paper (Fit To Paper Size)" as an example.

The Fit To Paper Size function is used to automatically enlarge or reduce the print image to fit the selected paper size. In this example, an A4-size image will be printed on A3-size paper.

The procedures for configuring printer driver settings vary by setting. **For more information on each setting, see "3. FREQUENTLY USED FUNCTIONS" and "4. CONVENIENT PRINTING FUNCTIONS" in the Printer Guide.**

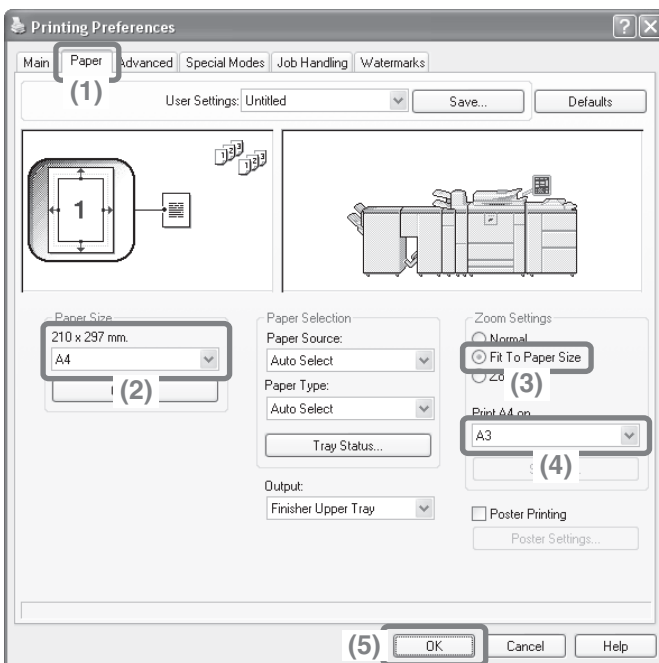

Select print settings.

- (1) Click the [Paper] tab.
- (2) Select [A4].
Select the size of the print image.
- (3) Select [Fit To Paper Size].
- (4) Select [A3].
Select the size of paper that you want to print on.
- (5) Click the [OK] button.

This completes the settings. Start printing.

Macintosh

The procedure for selecting printer driver settings is explained below using "Printing multiple images on one page (N-Up Printing)" as an example.

This function reduces the size of each page to let you print multiple pages on one sheet of paper. The example of printing two pages on one sheet of paper with borderlines is explained.

The procedures for configuring printer driver settings vary by setting. **For more information on each setting, see "3. FREQUENTLY USED FUNCTIONS" and "4. CONVENIENT PRINTING FUNCTIONS" in the Printer Guide.**

MAC OS X

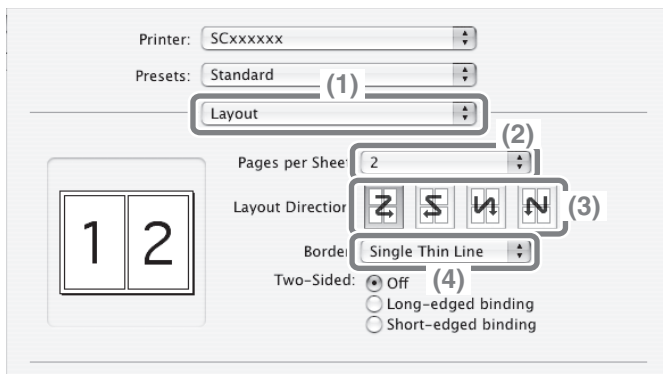

Select print settings.

- (1) Select [Layout].
- (2) Select [2].
- (3) Select the order of the pages.
- (4) Select the desired type of borderline.

MAC OS 9

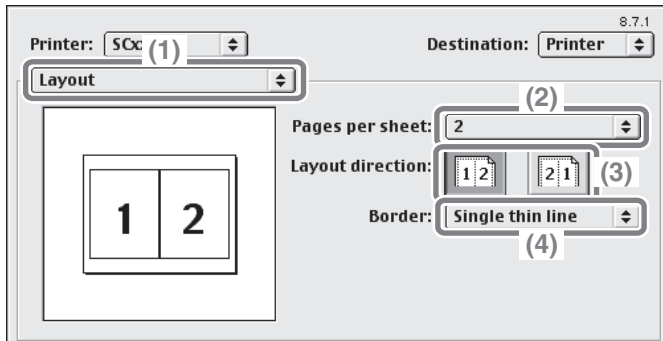

Select print settings.

- (1) Select [Layout].
- (2) Select [2].
- (3) Select the order of the pages.
- (4) Select the desired type of borderline.

CONVENIENT PRINTER FUNCTIONS

Printing on both sides of the paper (2-sided printing)

Use this function to print on both sides of the paper. You can use 2-sided printing to reduce the number of printed sheets when you are printing a large number of pages or when you wish to conserve paper.

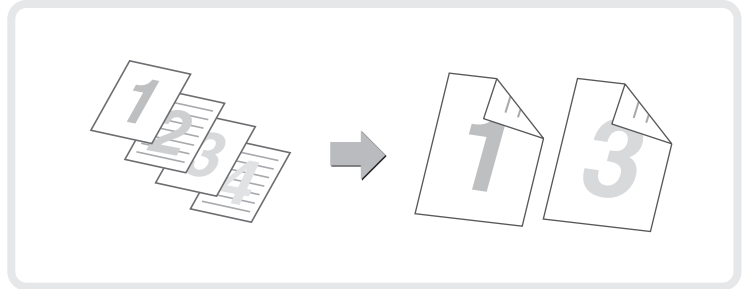

Fitting the print image to the paper (Fit To Paper Size)

Use this function to enlarge or reduce the print image to fit the paper size. This is convenient for such purposes as enlarging an A4 or letter size document to A3 or ledger size paper to make it easier to view, and to print when the same size of paper as the print image is not loaded in the machine.

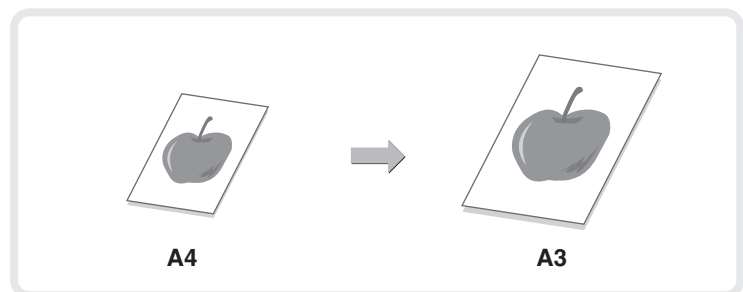

Printing multiple images on one page (N-Up Printing)

Use this function to print multiple pages on a single sheet of paper by reducing the size of the print images. This is convenient when you wish to show an overall view of multiple pages or conserve paper.

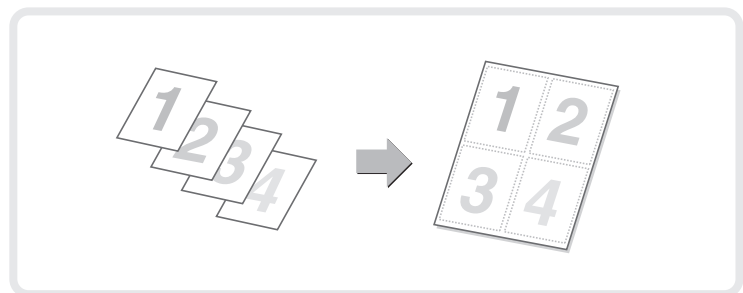

Stapling printed pages (Staple)

Use this function to staple printed output. (When a saddle stitch finisher or finisher is installed.)

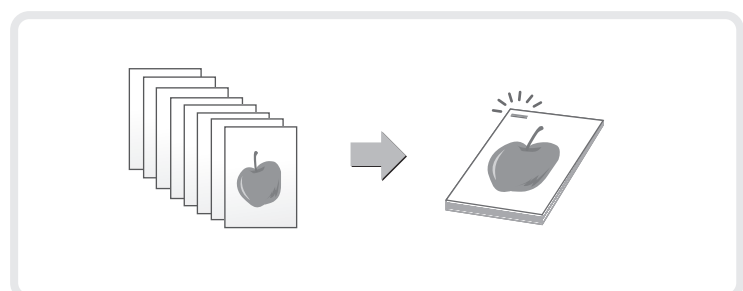

Punching holes in output (Punch)

Use this function to punch holes in output.
(When a punch module and saddle stitch finisher or finisher is installed.)

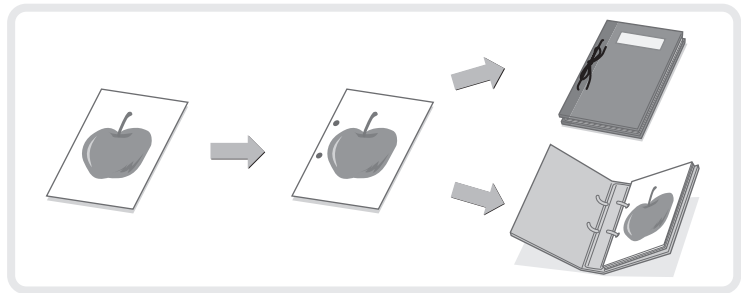

The machine also has these functions

For information on each of these functions, see "4. CONVENIENT PRINTING FUNCTIONS" in the Printer Guide.

Convenient functions for creating pamphlets and posters

- Creating a pamphlet (Pamphlet/Pamphlet Staple)
- Increasing margin (Margin Shift)
- Creating a large poster (Poster Printing)

Functions to adjust the size and orientation of the image

- Rotating the image 180 degrees (Rotate 180 degrees)
- Enlarging/reducing the print image (Zoom / XY-Zoom)
- Reversing the image (Mirror Image)

Image adjustment function

- Adjusting the brightness and contrast of the image (Image Adjustment)
- Printing faint text or lines in black (Text To Black/Vector To Black)

Functions to combine text and images

- Adding a watermark to printed pages (Watermark)
- Printing an image over the print data (Image Stamp)
- Creating overlays for print data (Overlays)

Print functions for special purposes

- Printing specified pages on different paper (Different Paper)
- Adding inserts when printing on transparency film (Transparency Inserts)
- Printing a carbon copy (Carbon Copy)
- Printing text on tabs of tab paper (Tab Printing)
- Two-sided printing with specific pages printed on the front side (Chapter Inserts Printing)
- Folding specified paper in half before printing (Paper Fold Print)
- Printing the pages in reverse order (Reverse Order Print)

Convenient printer functions

- Using two machines to print a large print job (Tandem Print)
- Saving and using print files (Retention/Document Filing)

Image Sending

This section explains the uses of the image send function and the basic procedure. In addition, special modes that can be used with the image send function are introduced.

To use the image send function, several expansion kits are necessary.

▶ IMAGE SEND FUNCTION	68
▶ BASE SCREEN OF IMAGE SEND MODE	69
▶ SCANNING AN ORIGINAL	70
▶ SENDING A FAX	71
▶ CONVENIENT TRANSMISSION METHODS	72
▶ STORING A DESTINATION	74
▶ SENDING THE SAME IMAGE TO MULTIPLE DESTINATIONS (Broadcast Transmission)	76
▶ CHANGING THE EXPOSURE AND ORIGINAL IMAGE TYPE	77
▶ CHANGING THE RESOLUTION	78
▶ CHANGING THE FILE FORMAT	80
▶ SPECIAL IMAGE SEND MODES	81
▶ SELECTING A SPECIAL MODE	82
▶ CONVENIENT IMAGE SEND FUNCTIONS	83

IMAGE SEND FUNCTION

The image send function of the machine can be used to transmit scanned images by a variety of methods. The image send function has the following modes.

Scan mode

Scan to E-mail

The scanned file is sent by e-mail.

Scan to FTP

The scanned file is sent to a specified directory on an FTP server.

Scan to Network Folder

The scanned file can be sent to a shared folder on a computer on your network. Transmission is possible to computers running Windows 98/Me/NT 4.0/2000/XP/Server 2003/Vista.

Scan to Desktop

The scanned file is sent to a specified folder on your computer. (To use Scan to Desktop, software must be installed from the "Sharpdesk/Network Scanner Utilities" CD-ROM that accompanies the network scanner expansion kit. For the procedures for installing the software, see the Sharpdesk Installation Guide.)

USB Memory mode

The scanned file is sent to and stored in a USB memory device* connected to the machine.

Internet Fax mode

A fax can be sent via the Internet. This function requires the expense of an Internet connection, however, if you already have Internet service or frequently send faxes, this function can help reduce communication costs.

Fax mode

This mode is used to send and received faxes.

* A USB memory device is a storage device that is connected via a USB interface.

BASE SCREEN OF IMAGE SEND MODE

Touch the [IMAGE SEND] key in the touch panel to open the base screen of image send mode. Various settings for image send can be selected from the base screen. Each mode has a base screen. To select a mode, touch the send mode select tab for that mode.

Example: Base screen of scan mode

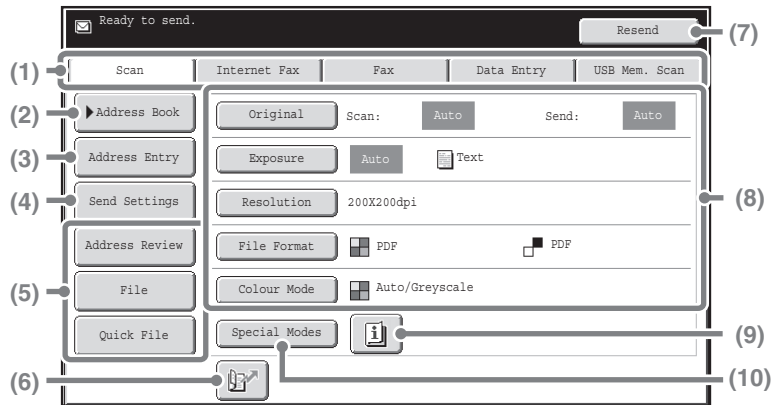

(1) Send mode tabs

Use these keys to change the mode of the image send function. For example, to switch to scan mode, touch the [Scan] tab.

(2) [Address Book] key

Touch this key to use a one-touch key or a group key. When the key is touched, the address book screen appears.

(3) [Address Entry] key

Touch this key to manually enter a destination address instead of using a one-touch key.

(4) [Send Settings] key

Touch this key to select or enter the subject, file name, sender name, or message text, which have been previously stored in the Web page.

(5) Customized keys

The keys that appear here can be changed to show settings or functions that you prefer.

(6) key

Touch this key to specify a destination using a search number*.

* 3-digit number assigned to a destination when it is stored.

(7) [Resend] key / [Next Address] key

The destinations of the most recent 8 transmissions by Scan to E-mail, fax and/or Internet fax are stored. Touch this key to select one of these destinations. When a destination is selected or entered, this key changes to the [Next Address] key.

(8) Image settings

Image settings (original size, exposure, resolution, file format, and colour mode) can be selected.

(9) key

This key appears when a special mode or 2-sided scanning is selected. Touch the key to display the selected special modes.

(10) [Special Modes] key

Touch this key to use a special mode.

SCANNING AN ORIGINAL

The basic operation for scanning is explained below.
This section explains how to send a scanned file by e-mail.
When the colour expansion kit is installed, originals can be scanned in full colour or greyscale.

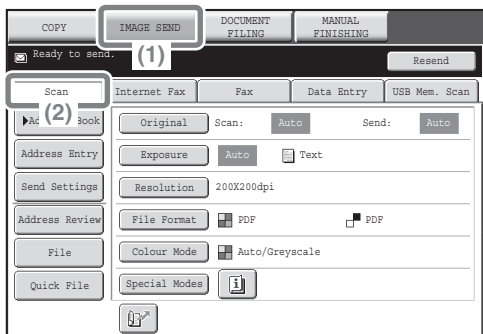
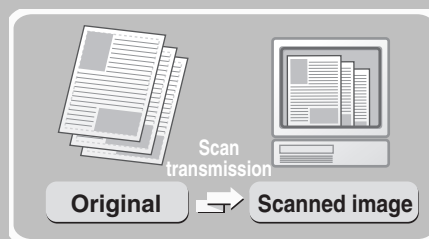

1 Select settings in the touch panel.

- (1) Touch the [IMAGE SEND] key.
- (2) Touch the [Scan] tab.
The base screen of scan mode appears.

The side to be scanned must be face up!



2 Place the originals.

When using the document glass, place the original with the side to be scanned face down.

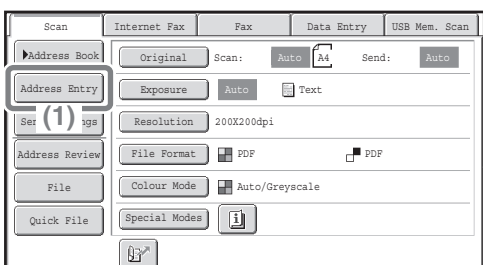

3 Select settings in the touch panel.

- (1) Touch the [Address Entry] key.
- (2) Touch the [To] key.
A text entry screen will appear. Enter the e-mail address of the recipient and touch the [OK] key.
For the procedure for entering text, see "7. ENTERING TEXT" in the User's Guide.

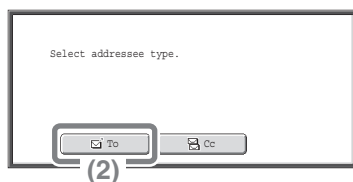

4 Press the [START] key.

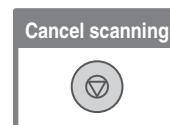

SENDING A FAX

The basic procedure for sending faxes is explained below.
In fax mode, colour originals are sent as black and white images.

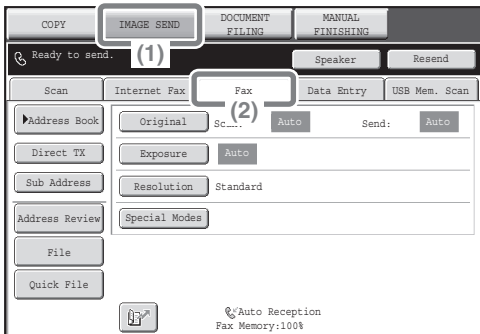
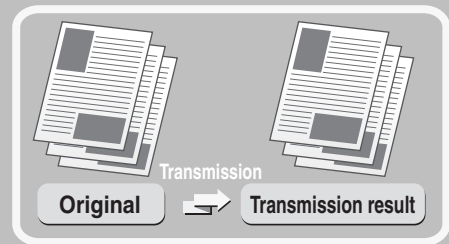

1 Select settings in the touch panel.

(1) Touch the [IMAGE SEND] key.

(2) Touch the [Fax] tab.

The base screen of fax mode appears.

The side to be scanned must be face up!



2 Place the originals.

When using the document glass, place the original with the side to be scanned face down.

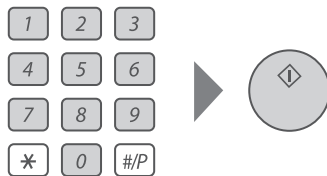

3 Enter the fax number of the receiving fax machine and press the [START] key.

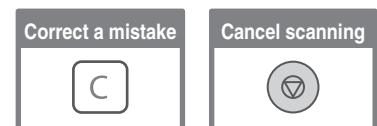

CONVENIENT TRANSMISSION METHODS

One-touch sending, resending, and other convenient transmission functions that make it easy to send an image are available.

One-touch key

A destination stored in a one-touch key can be retrieved by a simple touch of the key. For the procedure for storing a one-touch key, see "STORING A DESTINATION" (page 74).

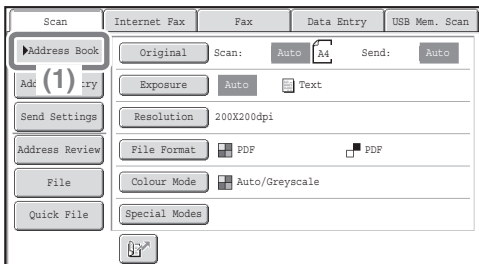

(1) Touch the [Address Book] key.

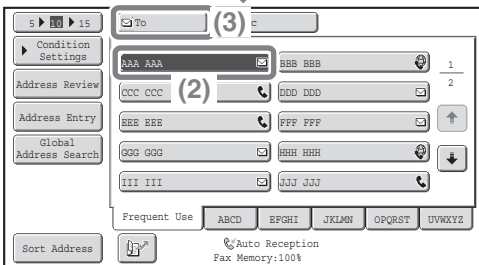

(2) Touch the key in which the desired destination is stored.

(3) Touch the [To] key.

- If an e-mail address is stored in the one-touch key, select [To] or [Cc] to specify the type of recipient after selecting the key.
- This step is not needed if you selected a one-touch key for a fax destination.

Search number sending

When you store an individual key or a group key, a 3-digit search number is assigned to the key.

You can select a destination using the  key and the 3-digit search number.

To check a search number, print the appropriate list in the sending address list menu in the system settings.

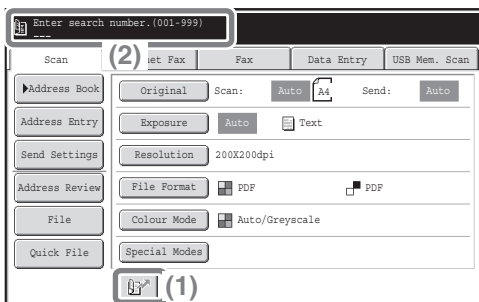

(1) Touch the  key.

(2) Enter the 3-digit search number with the numeric keys.

Resending

The [Resend] key can be touched to send an image to one of the most recent 8 transmission destinations. Resending is not possible in some cases, such as when an image is sent using a one-touch key for a group.

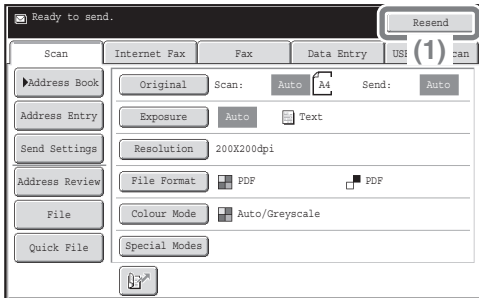

(1) Touch the [Resend] key.

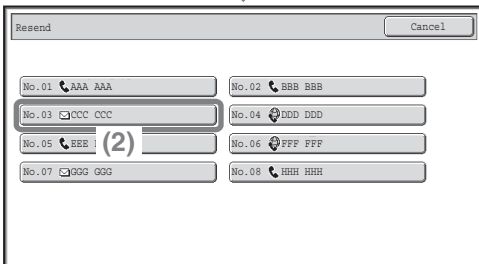

(2) Touch the key in which the desired destination is stored.

The transmission log can be used for Scan to E-mail, fax, and Internet fax destinations.

Dialling using the speaker (Fax mode)

When the speaker is used to dial, fax transmission is started after the number is dialled and the connection is established. If a person answers, you will be able to hear his or her voice, but you will not be able to speak.

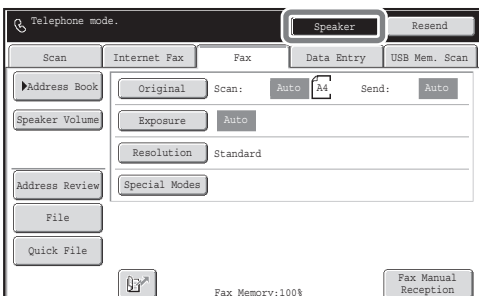

Touch the [Speaker] key.

You will hear the dial tone through the machine's speaker. Dial the fax number of the destination with the numeric keys or with the [Address Book] key.

When the connection is established, press the [START] key to send the fax.

STORING A DESTINATION

Destinations for Scan to E-mail, Internet fax, and fax can be stored in one-touch keys.

Stored destinations can be retrieved quickly and easily.

To store destinations for other modes, see "STORING DESTINATION ADDRESSES FOR EACH SCAN MODE IN THE ADDRESS BOOK" in the Image Send Guide.

Storing an individual key

As an example, the procedure for storing a destination for Scan to E-mail is explained below.

For the procedure for entering text, see "7. ENTERING TEXT" in the User's Guide.

SYSTEM
SETTINGS



1 Press the [SYSTEM SETTINGS] key.

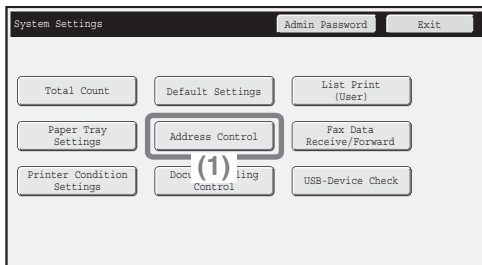

2 Select settings in the touch panel.

(1) Touch the [Address Control] key.

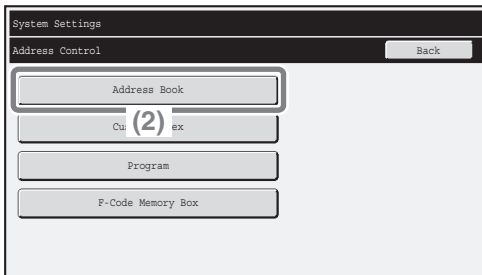

(2) Touch the [Address Book] key.

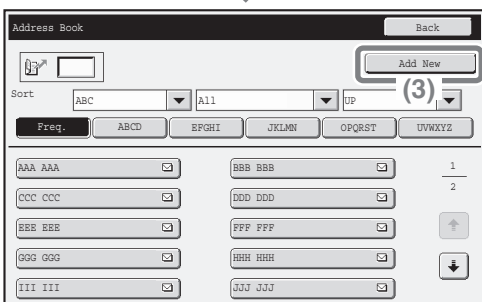

(3) Touch the [Add New] key.

Select settings in the touch panel. (Continued)

- (4) Select [E-mail] from the "Address Type" select box.

[Internet Fax] or [Fax] can be selected to store addresses for those modes.

- (5) Touch the "Address Name" text box.

A text entry screen appears. Enter the name of the destination (max. of 36 characters).

- (6) Touch the "Initial" text box.

A text entry screen appears. Enter search characters for the destination (max. of 10 characters).

- (7) Touch the scroll bar to move the screen.

- (8) Touch the "E-mail Address" text box.

A text entry screen appears. Enter the E-mail address that you want to store.

Likewise, when storing an Internet fax or fax destination, touch the text box and enter the Internet fax address or fax number in the text entry screen.

- (9) Touch the [OK] key.

The items in the above step must be entered. For details on items entered, see "9. SYSTEM SETTINGS" in the Image Send Guide.

When sending the same document or image to multiple destinations, it is convenient to store a destination group. For details on storing groups, see "9. SYSTEM SETTINGS" in the Image Send Guide.

SENDING THE SAME IMAGE TO MULTIPLE DESTINATIONS (Broadcast Transmission)

The same image can be sent to multiple scan mode (excluding Scan to Network Folder), Internet fax mode, and fax mode destinations in a single operation.

The procedure for selecting multiple destinations stored in one-touch keys and sending an image to those destinations is explained below.

The side to be scanned must be face up!



1 Place the originals.

When using the document glass, place the original with the side to be scanned face down.

2 Select settings in the touch panel.

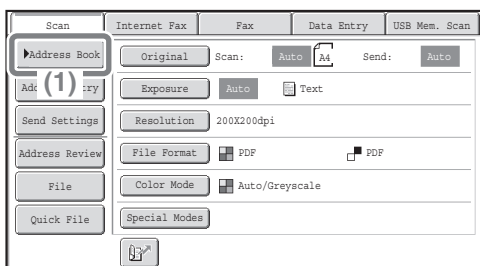

(1) Touch the [Address Book] key.

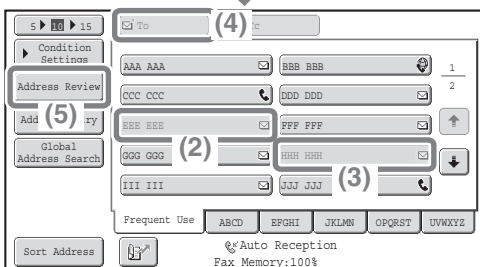

(2) Touch the one-touch key in which the desired destination is stored.

(3) Touch the one-touch keys of the additional destinations to which you want to send the image.

(4) Touch the [To] key.

(5) Touch the [Address Review] key.

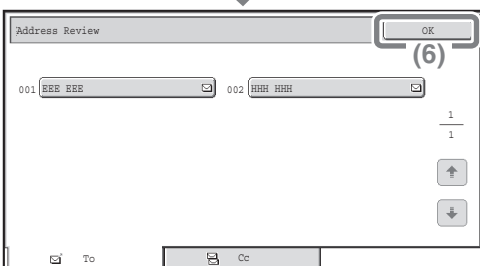

(6) Check the destinations and then touch the [OK] key.

To delete a destination, touch the key of the destination that you wish to delete. A message will appear to confirm the deletion. Touch the [Yes] key.

3 Press the [START] key.

When Internet fax or fax mode destinations are included in a broadcast transmission, transmission will take place in black & white even if the colour expansion kit is installed.

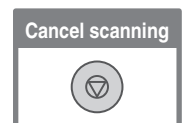

CHANGING THE EXPOSURE AND ORIGINAL IMAGE TYPE

Exposure and original image type settings can be selected as appropriate for the original. The procedure for darkening the exposure and setting the original image type to "Text/Prt'd. Photo" is explained below.

The side to be scanned must be face up!



1 Place the originals.

When using the document glass, place the original with the side to be scanned face down.

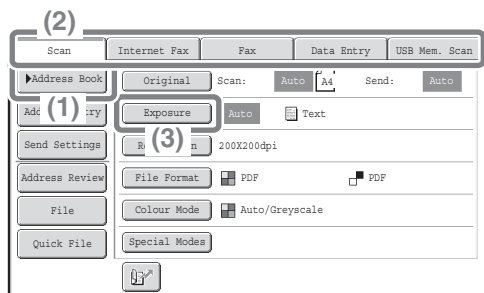

2 Select settings in the touch panel.

(1) Specify the destination.

For the procedures for specifying a destination, see "CONVENIENT TRANSMISSION METHODS" (page 72).

(2) Make sure that the desired mode ([Scan] tab) is selected.

(3) Touch the [Exposure] key.

(4) Read the displayed message and touch the [OK] key.

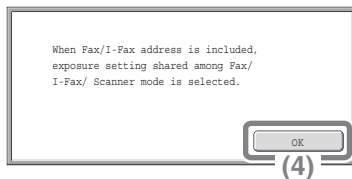

(5) Touch the [Manual] key.

(6) Darken light colours with the [D] key.

5 levels are available for the exposure. Darken light originals with the [D] key, and lighten dark originals with the [L] key.

(7) Touch the [Text/Prt'd. Photo] key.

In Internet fax/fax mode, the original image type and moire reduction cannot be selected.

(8) Touch the [OK] key.

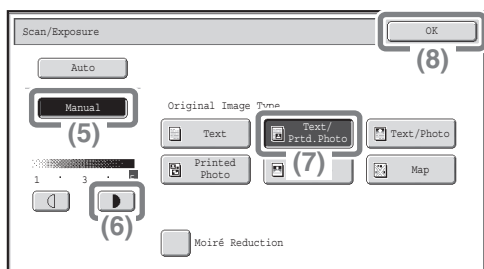

3 Press the [START] key.

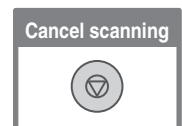

CHANGING THE RESOLUTION

You can select the resolution as appropriate for the original type.

Sending an image in scan mode

This section explains how to set the resolution to "300X300dpi", which creates a clearer image than the default resolution.

The side to be scanned must be face up!



1 Place the originals.

When using the document glass, place the original with the side to be scanned face down.

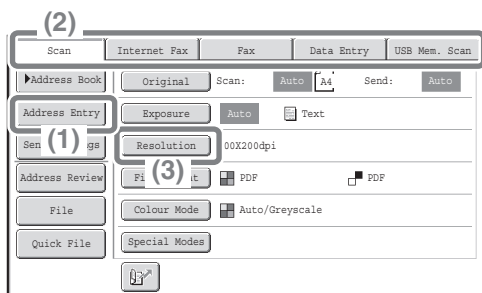

2 Select settings in the touch panel.

(1) Specify the destination.

For the procedures for specifying a destination, see "CONVENIENT TRANSMISSION METHODS" (page 72).

(2) Make sure that the desired mode ([Scan] tab) is selected.

(3) Touch the [Resolution] key.

(4) Touch the [300X300dpi] key.

(5) Touch the [OK] key.

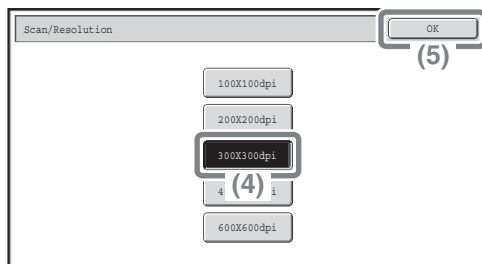

3 Press the [START] key.

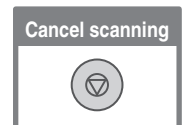

Sending an image in fax mode

The following example explains how to set the resolution to [Fine] and [Half Tone] when sending an original with small text.

The side to be scanned must be face up!



1 Place the originals.

When using the document glass, place the original with the side to be scanned face down.



2 Enter the fax number of the receiving fax machine.

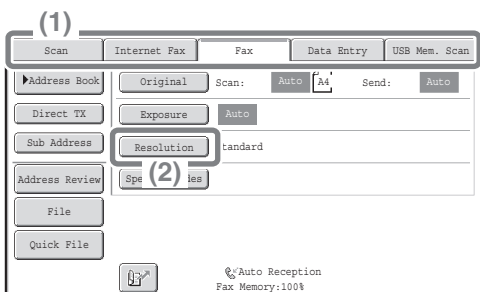

3 Select settings in the touch panel.

(1) Make sure that the desired mode ([Fax] tab) is selected.

(2) Touch the [Resolution] key.

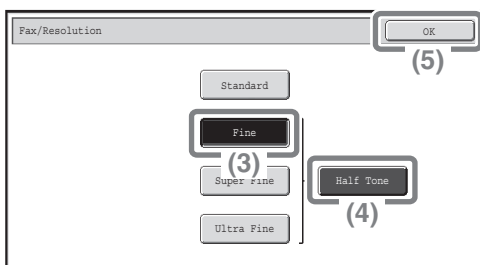

(3) Touch the [Fine] key.

The resolution increases (producing a clearer image) in the following order: [Standard], [Fine], [Super Fine], [Ultra Fine].

(4) Touch the [Half Tone] key.

Select [Half Tone] for a photo or illustration with shading to further improve the image.

[Half Tone] cannot be selected when [Standard] is selected.

(5) Touch the [OK] key.

4 Press the [START] key.

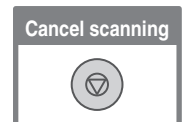

CHANGING THE FILE FORMAT

The format for scan send (file type and compression method) can be changed.

The procedure for sending a scanned image in full colour TIFF format is explained below.

* To scan an original in full colour, the colour expansion kit is required.

The side to be scanned must be face up!



1 Place the originals.

When using the document glass, place the original with the side to be scanned face down.

2 Select settings in the touch panel.

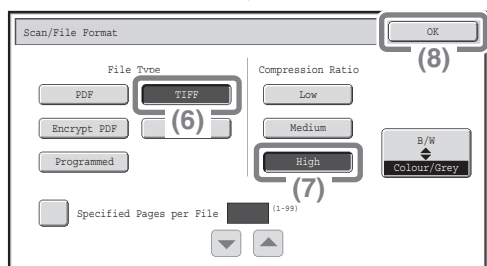
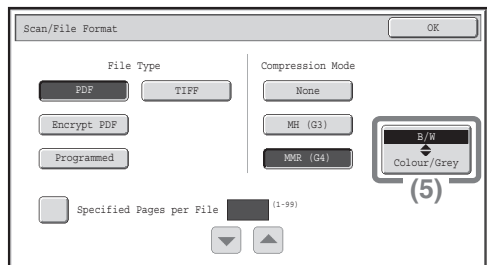
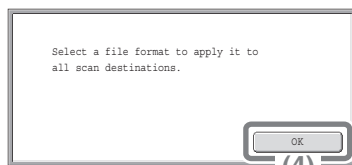
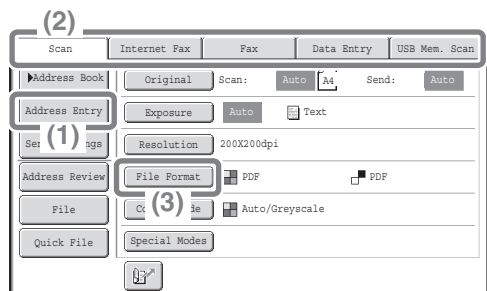

(1) Specify the destination.

For the procedures for specifying a destination, see "CONVENIENT TRANSMISSION METHODS" (page 72).

(2) Make sure that the desired mode ([Scan] tab) is selected.

(3) Touch the [File Format] key.

(4) Read the displayed message and touch the [OK] key.

(5) Change the mode to Colour/Greyscale mode.

If the colour expansion kit is not installed, the mode select key will not appear.

(6) Touch the [TIFF] key.

(7) Touch the [High] key.

This sets the compression to high.

A higher compression ratio creates a smaller file size.

(8) Touch the [OK] key.

3 Press the [START] key.

If the file type is set to [Encrypt PDF], you will be prompted to enter a password when you start transmission.

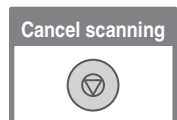

SPECIAL IMAGE SEND MODES

The special modes can be used for a variety of special-purpose scan send jobs.

The following pages show the types of scan send jobs that can be performed. (The procedures for using each special mode are not explained.)

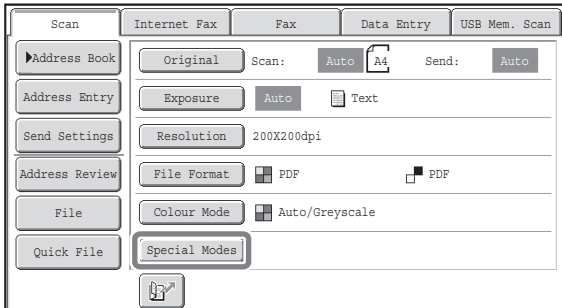

To use a special mode, open the special modes menu and touch the key of mode that you wish to use. The menu varies by mode.

Touch the [Special Modes] key in the base screen to open the special modes menu.

Example: Special modes screen of scanner mode 1st screen

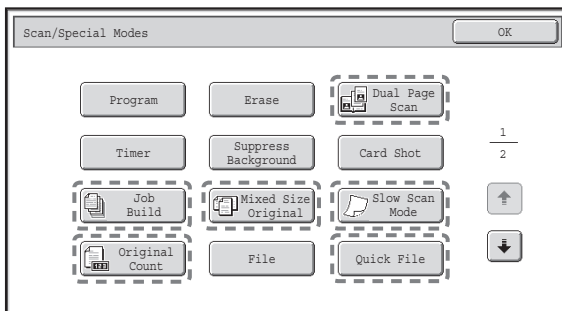

2nd screen

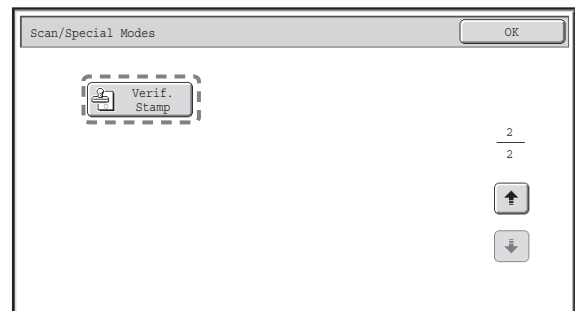

When a special mode key encircled by  is touched, the key is highlighted and the setting is completed. When any other special mode key is touched, a screen appears to let you select settings for that mode. The keys that appear vary by country and region and the peripheral devices that are installed.

Each special mode has its own settings and steps, however, the basic procedure is the same for all modes. The basic procedure for selecting a special mode is explained on the next page using "Erase" as an example.

For the procedures for using the special modes, see "4. SPECIAL MODES" in the Image Send Guide.

SELECTING A SPECIAL MODE

The procedure for selecting a special mode for image send is explained below. The settings that must be selected vary for each special mode, however, the general procedure is the same. As an example, the procedure for "ERASING PERIPHERAL SHADOWS ON THE IMAGE (Erase)" is explained.

The side to be scanned must be face up!



1 Place the originals.

When using the document glass, place the original with the side to be scanned face down.

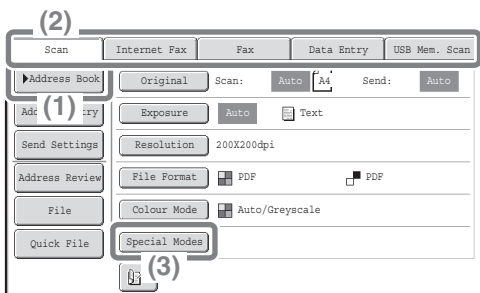

2 Select settings in the touch panel.

(1) Specify the destination.

For the procedures for specifying a destination, see "CONVENIENT TRANSMISSION METHODS" (page 72).

(2) Make sure that the desired mode ([Scan] tab) is selected.

(3) Touch the [Special Modes] key.

(4) Touch the [Erase] key.

The erase settings will be configured to erase a width of 3/4" around the edges of the original.

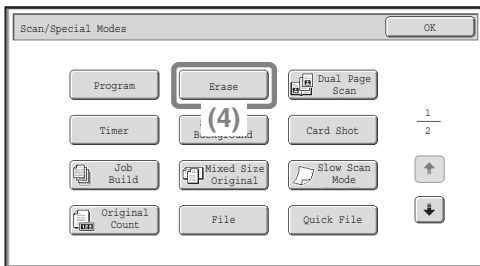

(5) Set the erasure width to 15 mm with the [down] [up] keys.

The erase area is set to "Edge Erase" by default. To select "Centre Erase", "Edge+Centre Erase" or "Side Erase" touch the appropriate key.

(6) Touch the [OK] key.

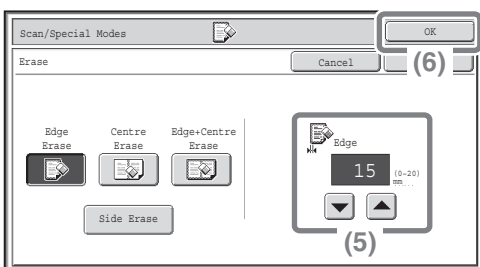

3 Press the [START] key.

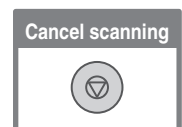

CONVENIENT IMAGE SEND FUNCTIONS

Erasing peripheral shadows on the image (Erase)

Use this function to erase peripheral shadows that occur when scanning books and other thick originals.

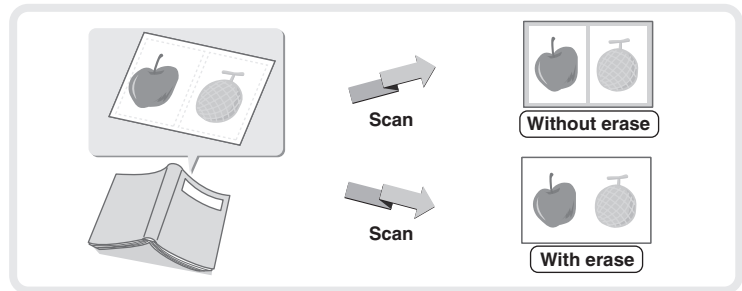

Sending an original as two separate pages (Dual Page Scan)

Use this function to scan the left and right pages of an open pamphlet or other bound document as separate pages.

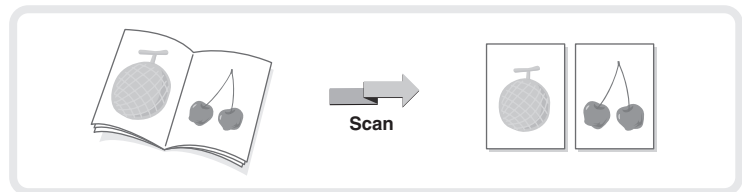

Whitening faint colours in the image (Suppress Background)

Use this function to suppress light background areas in the scanned image. This is convenient for scanning an original that is printed on coloured paper. To use this function, the colour expansion kit is required.

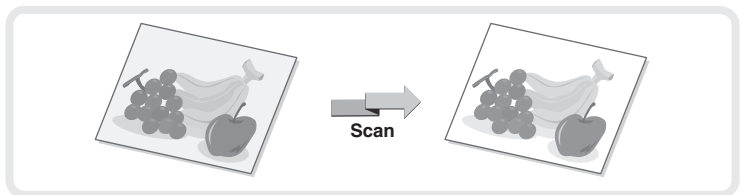

Sending both sides of a card as a single page (Card Shot)

Use this function to scan the front and back of a card as a single image.

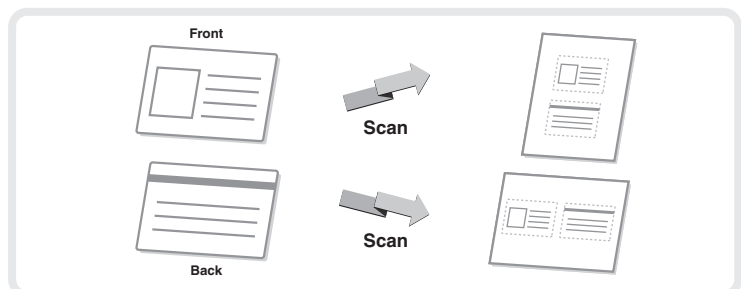

Scanning many originals at once (Job Build)

A stack of originals higher than the indicator line on the automatic document feeder cannot be scanned through the feeder.

The job build function lets you divide the stack of originals into sets, feed each set, and send the sets as a single transmission.

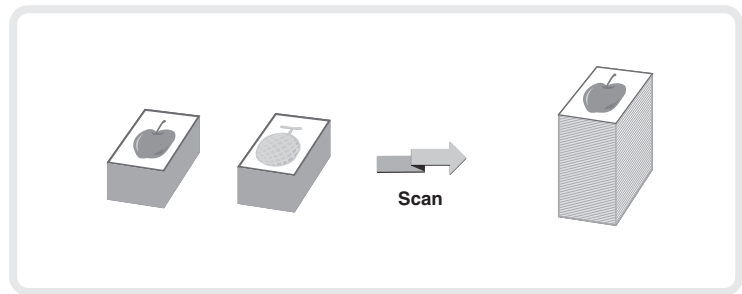

Sending two pages as a single page (2in1)

Use this function to reduce two original pages to half their size and send them as a single page.

This is a special function in Internet fax mode and fax mode.

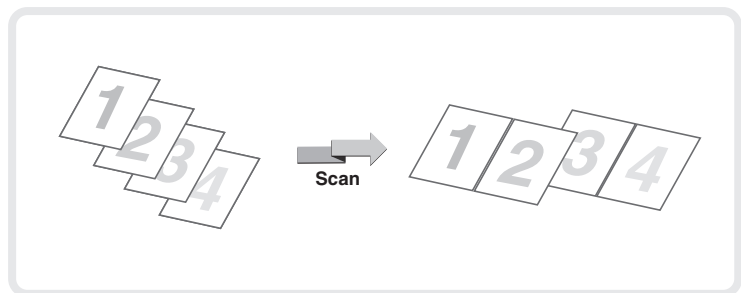

The machine also has these functions

For detailed information on these functions, see "4. SPECIAL MODES" in the Image Send Guide.

- Storing sending operations (Program)
 - Sending an image at a specified time (Timer Transmission)
 - Transmitting originals of different sizes (Mixed Size Original)
 - Scanning thin originals (Slow Scan Mode)
 - Original sheets before transmission (Original Count)
 - Stamping scanned originals (Verif. Stamp)
 - Changing the print settings for the transaction report (Transaction Report)
-
- Sending a computer file
For more information on these functions, see "3. TRANSMITTING AN IMAGE" in the Image Send Guide.
-
- F-code communication
 - Using an extension phone
For more information on this function, see "5. SPECIAL FAX FUNCTION" in the Image Send Guide.
-
- Forwarding received Internet faxes to an e-mail address (Inbound Routing Settings)
For more information on this function, see "6. RECEPTION FUNCTIONS" in the Image Send Guide.

Document filing

The document filing function is used to store the document or print image on the hard drive when performing a copy, print, or other job. A stored file can be called up and used whenever needed.

This section introduces several of the document filing functions.

- ▶ **DOCUMENT FILING** 86
- ▶ **QUICKLY SAVING A JOB (Quick File)** 88
- ▶ **APPENDING INFORMATION WHEN STORING A FILE (File)** 89
- ▶ **SAVING A DOCUMENT ONLY (Scan to HDD)** 91
- ▶ **PRINTING A SAVED FILE** 92

DOCUMENT FILING

The document filing function allows you to save the document image of a copy or image send job, or the data of a print job, as a file on the machine's hard drive.

The stored file can be retrieved and printed or transmitted as needed.

Uses of the document filing function

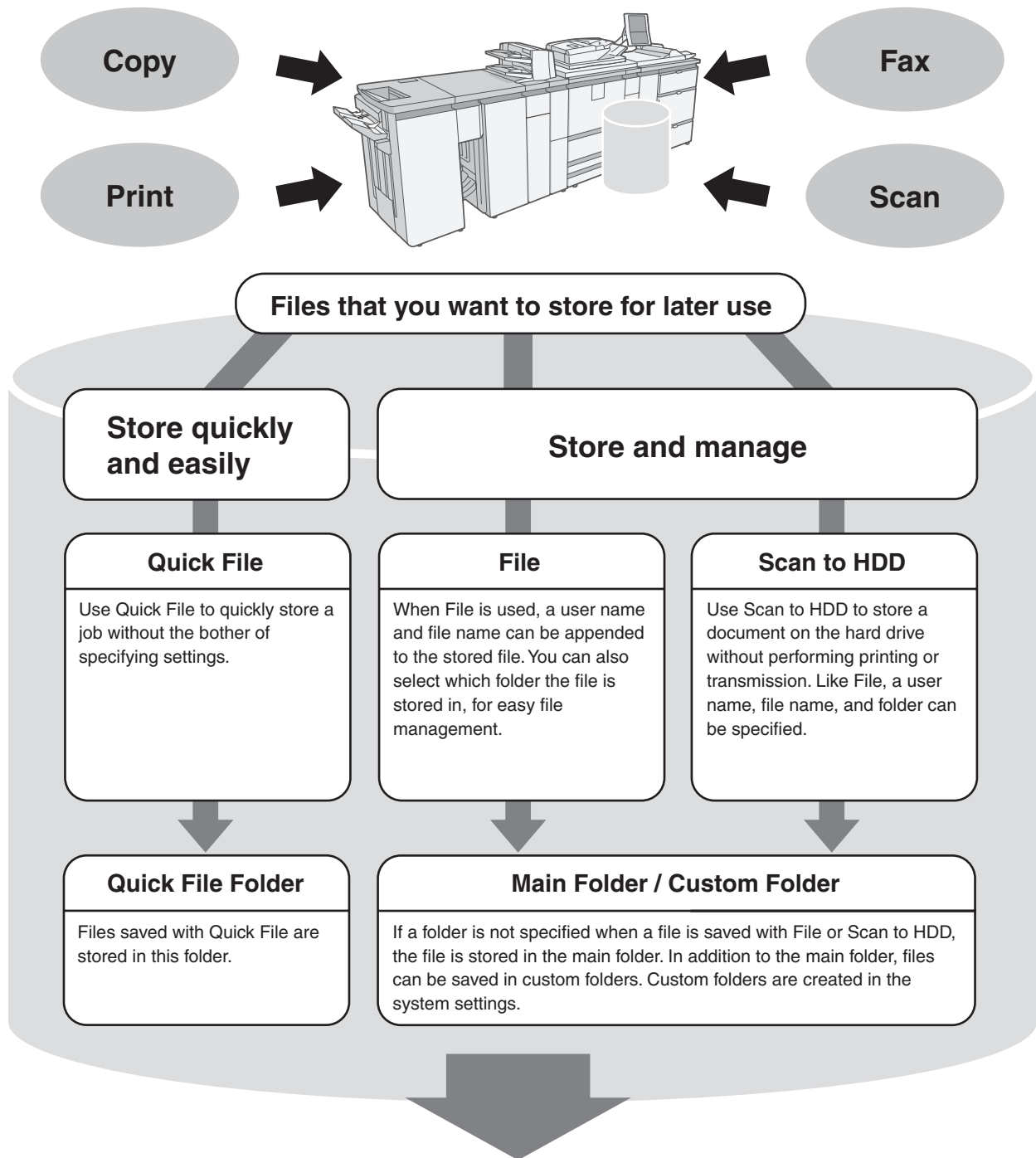

The document filing function is convenient in these situations

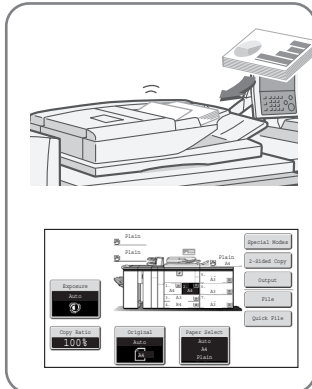
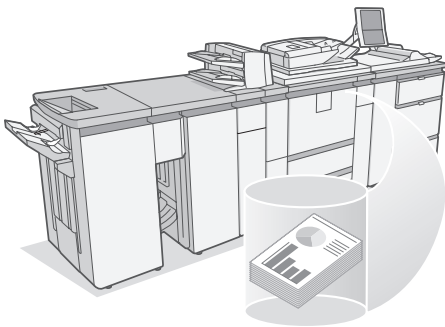

In this situation...

You prepared copies of a many-page handout for a meeting, but the number of participants suddenly increases and you need to quickly prepare more copies of the handout.



Document filing is convenient

It takes time to scan all of the pages of the handout. And the copy settings must be selected again. In this situation, there is no need to panic. Simply print the file that you stored using document filing. There is no need to scan the originals or select the copy settings again.

In this situation...

Forms for daily or weekly reports are kept in the office, but they are often used up and you have to print more using the original file.



Document filing is convenient

If you store the forms for daily or weekly reports together in a folder, users can obtain a form using the Web page or the operation panel of the machine.

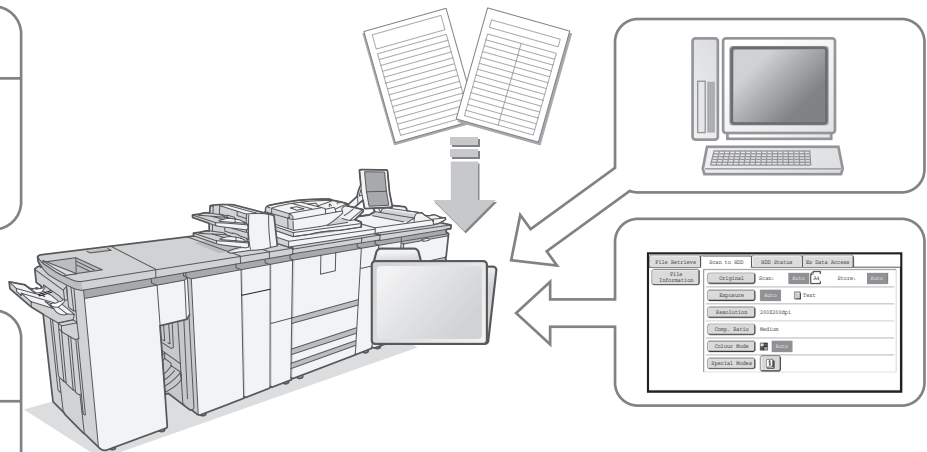

Features that make the document filing function even more convenient

When user authentication is enabled, "My Folder" can be specified in the user information of the users. When a user retrieves a stored file, "My Folder" appears first, saving the user the trouble of selecting the folder. For information on setting up "My Folder", see "User List" in the Administrator's Guide.

QUICKLY SAVING A JOB (Quick File)

As an example, the procedure for using "Quick File" while copying is explained below. Quick File is the easiest way to save a file using the document filing function.

The side to be scanned must be face up!



1 Place the originals.

When using the document glass, place the original with the side to be scanned face down.

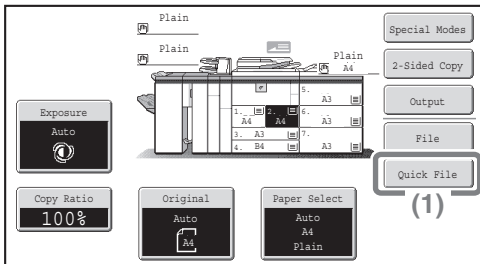

2 Select settings in the touch panel.

Select settings in the same way as when making a regular copy.

(1) Touch the [Quick File] key.

(2) Touch the [OK] key.

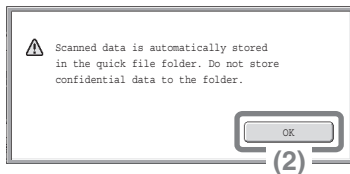

3 Set the number of copies and then press the [START] key.

The file is stored on the hard drive at the same time as the copy is made.

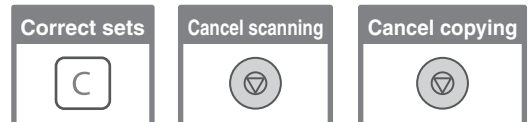
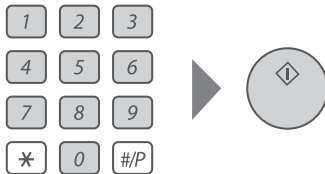

APPENDING INFORMATION WHEN STORING A FILE (File)

As an example, the procedure for using "File" while copying is explained below. Unlike Quick File, a file name, user name, folder, and save format can be specified when saving a file.

A saved file can be printed or sent at a later time. When saving a file to be sent, set the save format to "Send Allowed Mode".

The side to be scanned must be face up!



1 Place the originals.

When using the document glass, place the original with the side to be scanned face down.

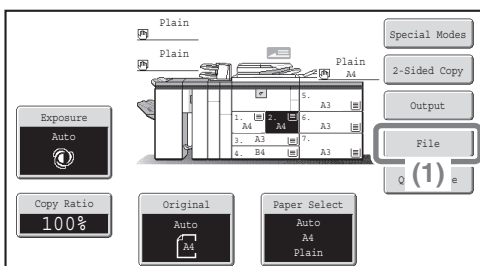

2 Select settings in the touch panel.

Select settings in the same way as when making a regular copy.

(1) Touch the [File] key.

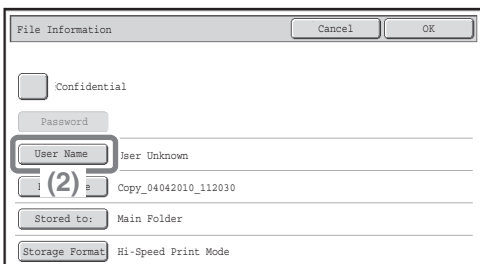

(2) Touch the [User Name] key.

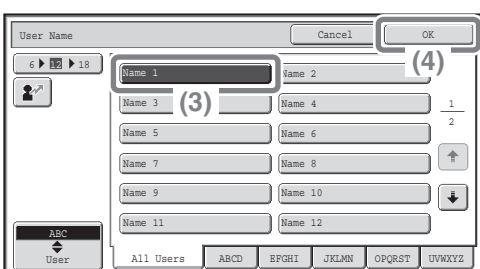

(3) Touch the [Name 1] key.

(4) Touch the [OK] key.

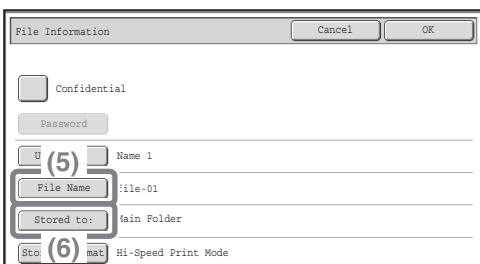

(5) Touch the [File Name] key.

A text entry screen appears. Enter a file name (maximum of 30 characters). For the procedure for entering text, see "7. ENTERING TEXT" in the User's Guide.

(6) Touch the [Stored to:] key.

Select settings in the touch panel. (Continued)

(7) Touch the [User 1] key.

(8) Touch the [OK] key.

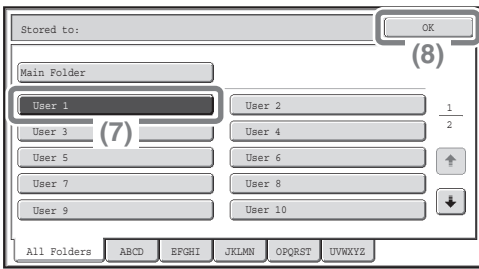

(9) Touch the [OK] key.

Two selections are available for the "Storage Format": "Hi-Speed Print Mode" and "Send Allowed Mode". Select "Hi-Speed Print Mode" if you wish to give priority to printing speed. Select "Send Allowed Mode" if you wish to allow the stored document to be sent at a later time.

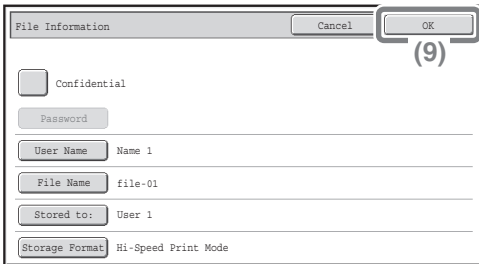

3 Set the number of copies and then press the [START] key.

The file is stored on the hard drive at the same time as the copy is made.

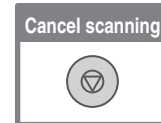
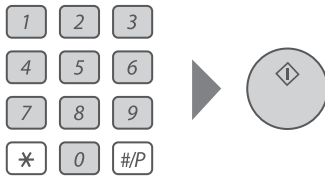

SAVING A DOCUMENT ONLY (Scan to HDD)

You can save a document without performing a copy, print, or send job.
The procedure for storing a document in the main folder is explained below.
When the colour expansion kit is installed, originals can be scanned in full colour or greyscale.

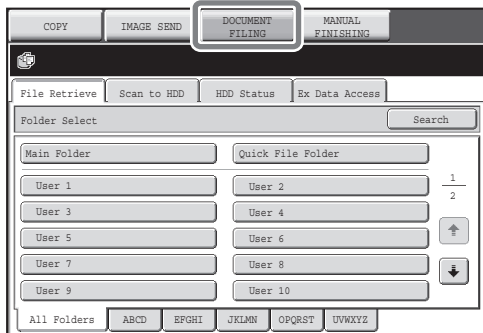

- 1 Touch the [DOCUMENT FILING] key.**
The base screen of document filing mode appears.

The side to be scanned must be face up!



- 2 Place the originals.**
When using the document glass, place the original with the side to be scanned face down.

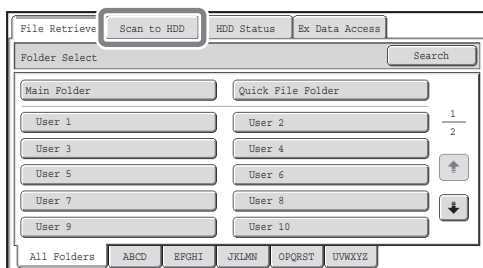

- 3 Touch the [Scan to HDD] tab.**

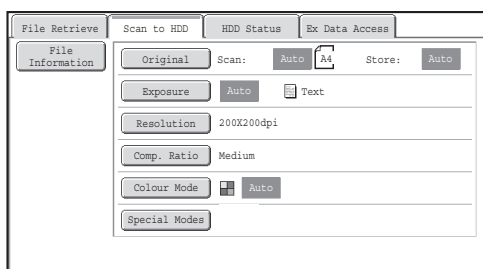

The Scan to HDD base screen appears.
To specify a user name, file name, and folder, touch the [File Information] key.



- 4 Press the [START] key.**

PRINTING A SAVED FILE

You can retrieve a file stored by document filing and print or transmit the file. This section explains how to retrieve and print a file stored in the main folder.

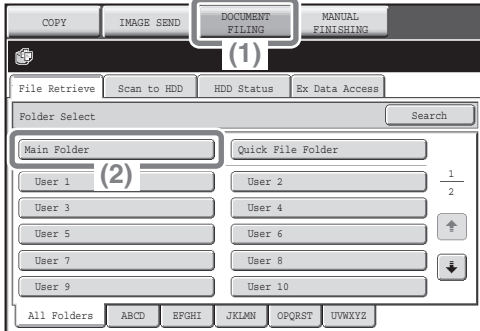

Select the file and print it.

- (1) Touch the [DOCUMENT FILING] key.
- (2) Touch the [Main Folder] key.

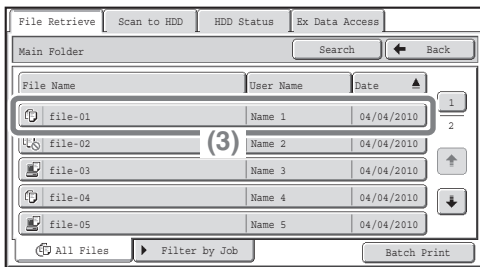

- (3) Touch the key of the file that you wish to retrieve.

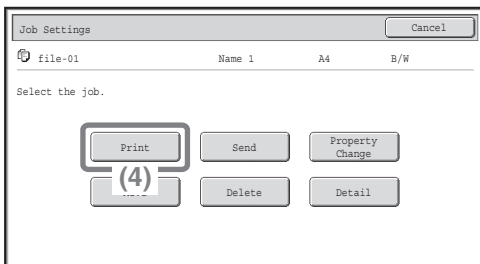

- (4) Touch the [Print] key.

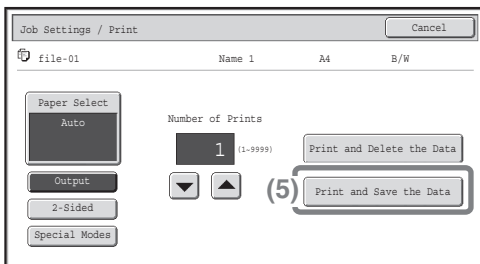

- (5) Touch the [Print and Save the Data] key. When [Print and Save the Data] is selected, the file is saved after printing. To delete the file after printing it, select [Print and Delete the Data].

Manual finishing

This section explains the basic procedures for using the manual finishing function.

- ▶ **MANUAL FINISHING 94**
- ▶ **USING MANUAL FINISHING 95**

MANUAL FINISHING

Manual finishing can be used to staple or punch holes in paper that has been loaded in the inserter. Copying and printing are not performed when the manual finishing function is used. As an example, manual finishing can be used to staple paper on which printing or copying has already been performed and thereby create booklets.

For detailed information, see "MANUAL FINISHING MODE" in the User's Guide.

Base screen

Touch the [MANUAL FINISHING] key in the touch panel to open the base screen of manual finishing mode. Staple, punch, and folding settings are selected from the base screen.

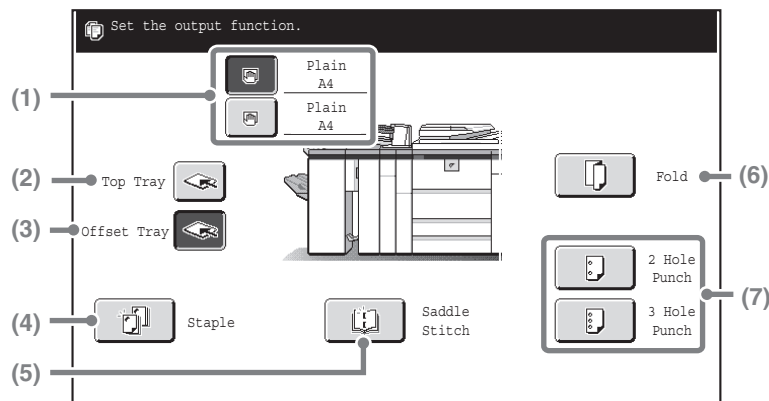

(1) [Top Inserter Tray] key, [Bottom Inserter Tray] key

Select the tray in which you have loaded paper.

(2) [Top Tray] key

This sets the top tray of the finisher as the output tray.

(3) [Offset Tray] key

This sets the offset tray of the finisher as the output tray.

(4) [Staple] key

Use this to staple the loaded paper. When this key is touched, keys for selecting the stapling positions will appear.

(5) [Saddle Stitch] key

Use this to staple and fold the loaded paper at the centreline.

(6) [Fold] key

Use this to fold the loaded paper in half.

(7) [2 Hole Punch] key, [3 Hole Punch] key

Use this to punch holes in the loaded paper.

USING MANUAL FINISHING

The basic procedure for using manual finishing is explained below, using stapling as an example.

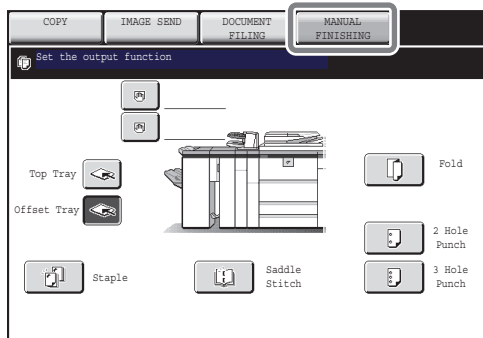

- 1 Touch the [MANUAL FINISHING] key.**
The base screen of manual finishing mode appears.

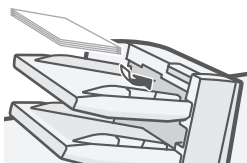

The "front" side must face up!

- 2 Load the paper that you want to staple in the inserter tray.**
All loaded sheets will be stapled as a single set.

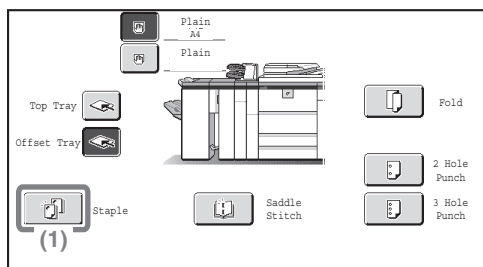

- 3 Select settings in the touch panel.**
(1) Touch the [Staple] key.

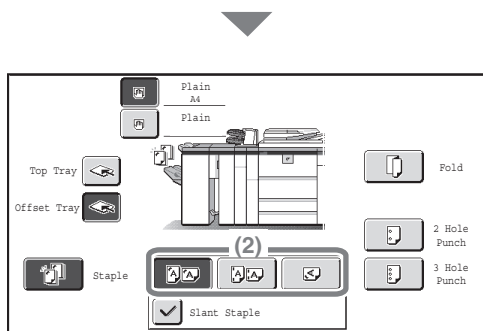

- (2) Touch the key of the desired stapling location.**

- 4 Press the [START] key.**



System settings

The system settings let you adjust the operation of the machine to suit the needs of your workplace. This section briefly introduces several of the system settings.

▶ SYSTEM SETTINGS	98
▶ SYSTEM SETTINGS MENU	100

SYSTEM SETTINGS

The date and time can be set, fax and scan destinations can be stored, document filing folders can be created, and various other settings related to the operation of the machine can be configured in the system settings screen.

The procedure for opening the system settings screen and the items in the screen are explained below.

Displaying the system settings screen

SYSTEM
SETTINGS



Press the [SYSTEM SETTINGS] key.

The system settings screen will appear.

The keys that appear will vary depending on what peripheral devices are installed.

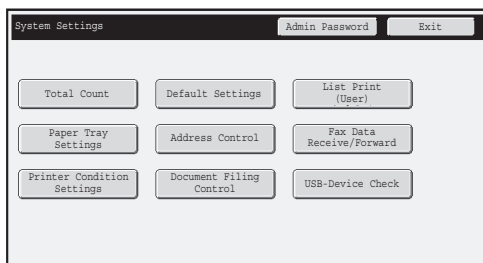

What you can do in the system settings

The following table shows the items that appear when the [SYSTEM SETTINGS] key is pressed in the factory default state.

For the complete system settings menu, see "SYSTEM SETTINGS MENU" (page 100).

Settings	Description
Total Count	This displays the total number of pages printed by job type such as copy jobs and print jobs.
Default Settings	This lets you set the clock and change the software keyboard used for text entry.
List Print (User)	This lets you print lists showing the machine status and settings.
Paper Tray Settings	This is used to set the type and size of paper used in each tray, and to store new paper types.
Address Control	Destinations for the image send function can be stored in one-touch keys, and settings can be stored in program keys.
Fax Data Receive/Forward	This is used to configure settings for receiving faxes and Internet faxes, and settings for forwarding received faxes and Internet faxes.
Printer Condition Settings	This is used to configure settings for printing without using the printer driver and settings for the printer function.
Document Filing Control	This is used to store, edit, and delete custom folders for the document filing function.
USB-Device Check	This is used to check the connection status of a USB device.

System settings (administrator)

The system settings (administrator)* are system settings that can only be configured by the administrator of the machine. To configure these settings, the administrator password must be entered.

However, when user authentication is enabled, users who log in with certain user rights may be able to configure these settings without entering the administrator password. Check with your administrator.

* Although the manuals for the machine indicate system settings that require administrator rights as "system settings (administrator)", this is only for convenience in explaining the settings. The word "administrator" does not appear in the touch panel or elsewhere on the machine.

For the items of the system settings (administrator), see the Administrator's Guide. (You can also refer to the "SYSTEM SETTINGS MENU" on the next page.)

Manuals containing explanations of the system settings

Explanations of the system settings can be found in several different manuals, depending on the function and required rights. Refer to the following table to determine where an explanation can be found.

Operation manual	System setting item
User's Guide	<ul style="list-style-type: none">• Total Count• Default Settings• List Print (User)• Paper Tray Settings• USB-Device Check
Printer Guide	<ul style="list-style-type: none">• Printer Condition Settings
Image Send Guide	<ul style="list-style-type: none">• Address Control• Fax Data Receive/Forward
Document Filing Guide	<ul style="list-style-type: none">• Document Filing Control
Administrator's Guide	<ul style="list-style-type: none">• System settings (administrator)

SYSTEM SETTINGS MENU

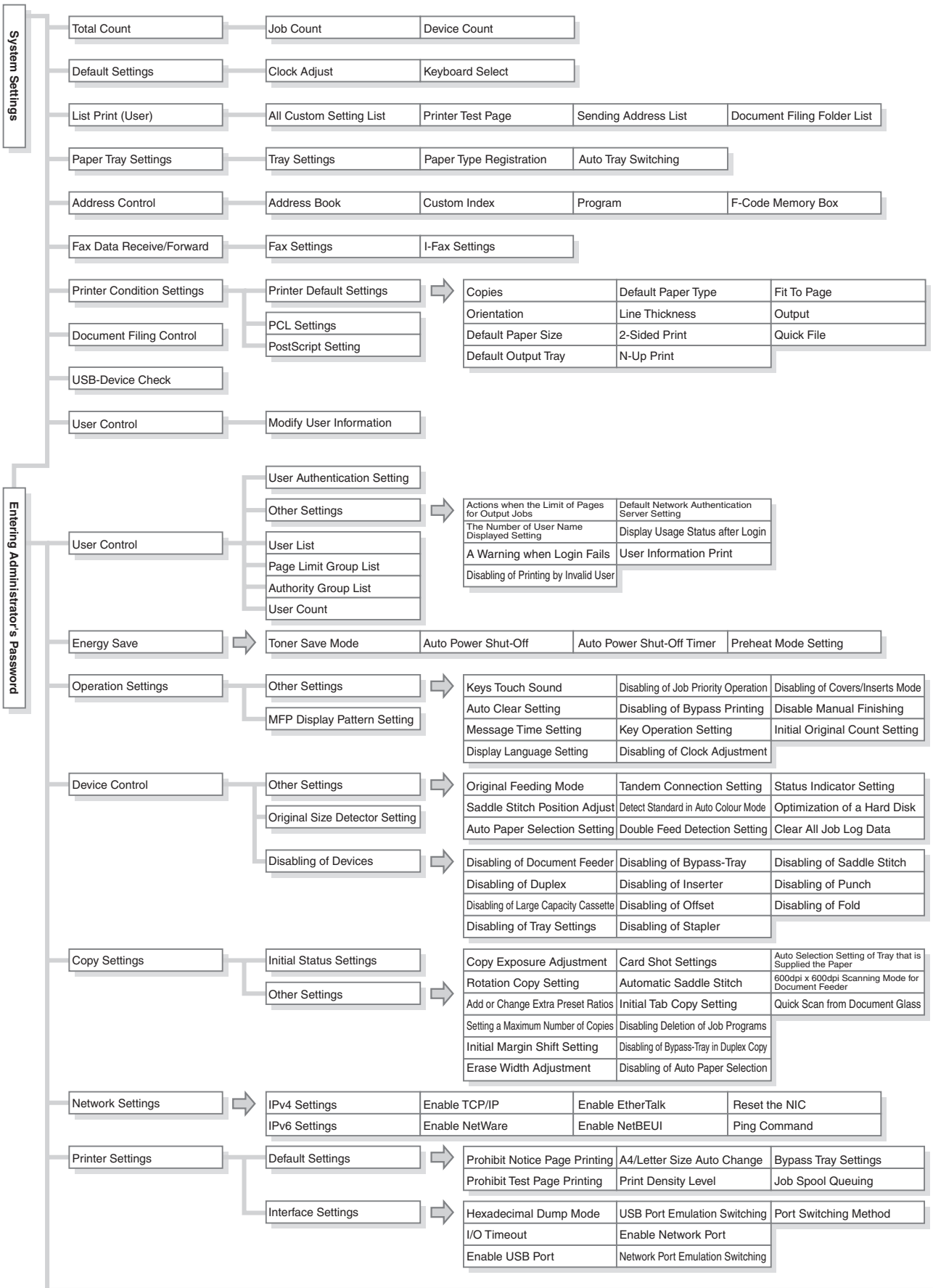

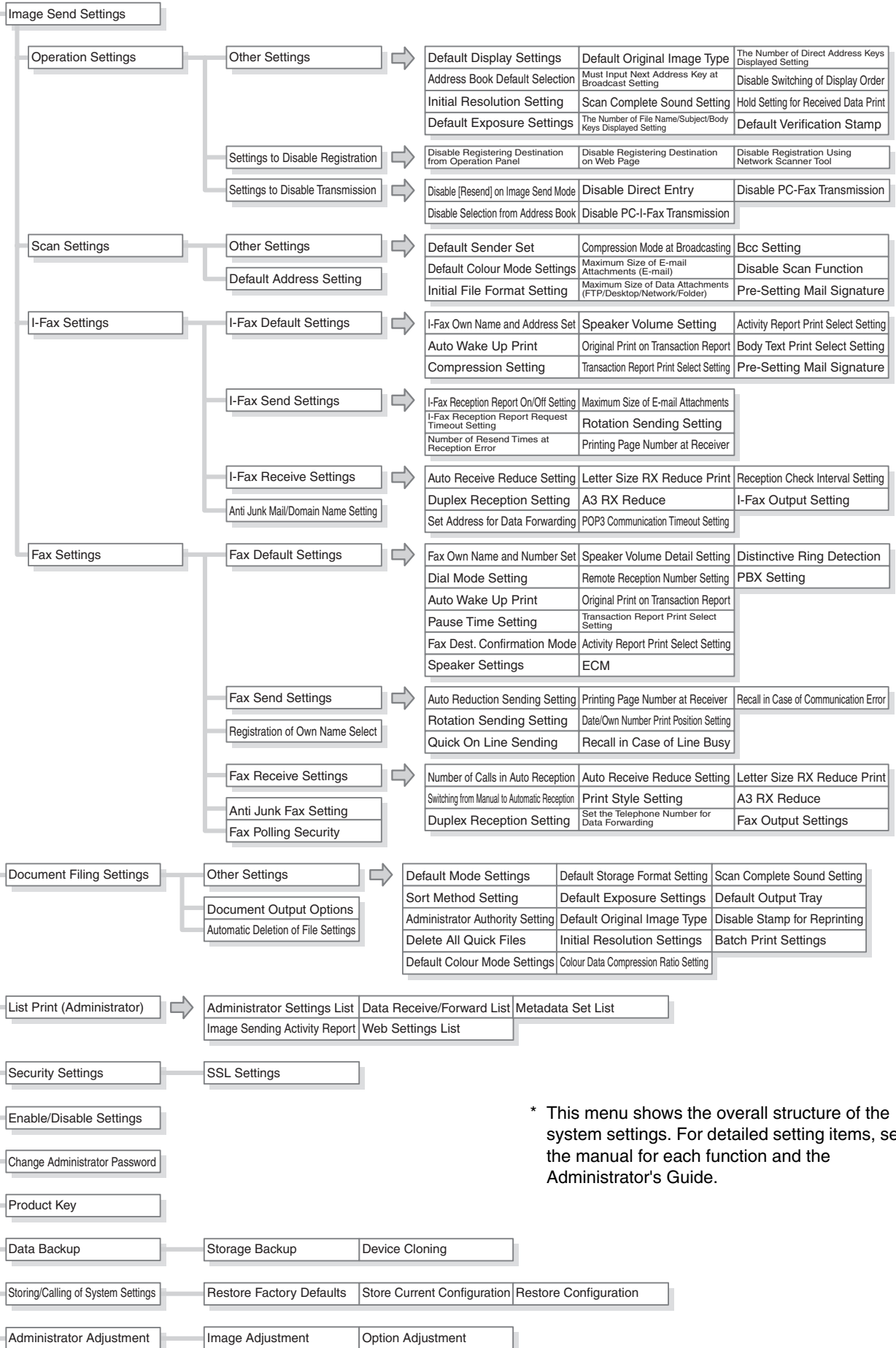

* This menu shows the overall structure of the system settings. For detailed setting items, see the manual for each function and the Administrator's Guide.

Please note

- For information on your operating system, please refer to your operating system manual or the online Help function.
- The explanations of screens and procedures in a Windows environment are primarily for Windows® XP. The screens may vary depending on the version of the operating system or the software application.
- The explanations of screens and procedures in a Macintosh environment are based on Mac OS X v10.4 in the case of Mac OS X, and on Mac OS 9.2.2 in the case of Mac OS 9. The screens may vary depending on the version of the operating system or the software application.
- Wherever "MX-xxxx" appears in this manual, please substitute your model name for "xxxx".
- Considerable care has been taken in preparing this manual. If you have any comments or concerns about the manual, please contact your dealer or nearest authorised service representative.
- This product has undergone strict quality control and inspection procedures. In the unlikely event that a defect or other problem is discovered, please contact your dealer or nearest authorised service representative.
- Aside from instances provided for by law, SHARP is not responsible for failures occurring during the use of the product or its options, or failures due to incorrect operation of the product and its options, or other failures, or for any damage that occurs due to use of the product.
- This manual contains references to the fax function. However, please note that the fax function is not available in some countries and regions.

Warning

- Reproduction, adaptation or translation of the contents of the manual without prior written permission is prohibited, except as allowed under copyright laws.
- All information in this manual is subject to change without notice.

Illustrations and the operation panel and touch panel shown in this manual

The peripheral devices are generally optional, however, some models include certain peripheral devices as standard equipment. The explanations in this manual assume that a finisher, punch module, saddle unit, folding unit, inserter, large capacity trays, and bypass tray are installed on the MX-M1100.

For some functions and procedures, the explanations assume that devices other than the above are installed.

<p>The display screens, messages, and key names shown in the manual may differ from those on the actual machine due to product improvements and modifications.</p>
--

SHARP[®]

SHARP CORPORATION

PRINTED IN FRANCE
TINSE3743GHZZ

